

MULTI CHANNEL AV RECEIVER
STR-DN1050/STR-DN850



Use this Help Guide when you have any questions on how to use the receiver.

In this Help Guide, STR-DN1050 is used for illustration purposes unless when otherwise indicated.

The picture above is of the STR-DN1050.

[Preparation](#)



[Enjoying Video and Sound](#)



[Using Network Features](#)



[Using BLUETOOTH Features](#)



[Using the Multi-Zone Features \(for STR-DN1050 only\)](#)



[Using Other Features](#)



[Adjusting Settings](#)



[Parts and Controls](#)



[Announcements](#)



[Troubleshooting](#)





MULTI CHANNEL AV RECEIVER
STR-DN1050/STR-DN850

Preparation

[Before using](#)



[Installing and connecting speakers](#)



[Connecting audio-visual devices and the antennas \(aerials\)](#)



[Connecting to the network](#)



[Turning on the receiver/preparing the remote control](#)



[Initial setup of the receiver](#)



[Notes on use](#)

4-488-938-11(1)

Copyright 2014 Sony Corporation

Table Of Contents

Help Guide STR-DN1050/STR-DN850.....	i
Preparation.....	ii
Before using.....	13
Procedure to start using the receiver.....	73
Supplied accessories.....	74
Function for conversion of video signals.....	75
Digital audio formats supported by the receiver.....	76
Notes on connecting cables.....	78
Using HDMI connections.....	79
Using MHL (Mobile High-Definition Link) connections.....	80
Installing and connecting speakers.....	14
Installing speakers.....	81
Connecting speakers.....	82
Connecting the speakers in zone 2 (for STR-DN1050 only).....	84
Connecting audio-visual devices and the antennas (aerials).....	15
Connecting a TV (for STR-DN1050).....	85
Connecting a TV (for STR-DN850).....	89
Connecting devices with HDMI jacks.....	92
Connecting devices with jacks other than HDMI jacks (for STR-DN1050).....	94
Connecting devices with jacks other than HDMI jacks (for STR-DN850).....	96
Connecting an iPhone, iPod, or USB device.....	98
Connecting an MHL-compatible mobile device.....	99
Connecting the antennas (aerials).....	100
Connecting another amplifier in zone 2 (for STR-DN1050 only).....	101
Connecting to the network.....	16
Connecting the receiver to the network using a LAN cable (for wired LAN connections only).....	103
Connecting the receiver to the network using the wireless LAN antenna (for wireless LAN connections only).....	104
Turning on the receiver/preparing the remote control.....	17
Setting the voltage selector.....	105
Inserting batteries into the remote control.....	106
Turning on the receiver.....	107
Initial setup of the receiver.....	18
Setting up the receiver using the Easy Setup.....	108
Enjoying Video and Sound.....	1
Basic operations.....	19
Using the menu on the TV screen.....	109

Enjoying video/sound from the connected device.....	110
Playing content from an iPhone/iPod.....	20
Compatible iPhone/iPod/iPad models.....	112
Notes on iPhone/iPod.....	113
Enjoying audio content stored on an iPhone/iPod via the USB port.....	114
Enjoying audio content from iTunes or an iPhone/iPad/iPod via the network (AirPlay).....	115
Enjoying audio content stored on a BLUETOOTH device.....	117
Playing content from a USB device.....	21
Compatible USB devices and USB specifications.....	119
Notes on USB devices.....	122
Enjoying audio content stored on a USB device.....	123
Listening to the radio.....	22
Listening to FM/AM radio.....	124
Presetting FM/AM radio stations (Preset Memory).....	125
Tuning to a station directly (Direct Tuning).....	126
Changing the AM tuning scale (for USA, Canadian, and Mexican models only).....	127
Receiving RDS broadcasts (for European and Australian models only).....	128
Enjoying sound effects.....	23
Selecting a sound field (Sound Field).....	129
Resetting sound fields to the default settings.....	130
Adjusting the equalizer (Equalizer).....	131
Enjoying clear and dynamic sound at a low volume (Sound Optimizer).....	132
Selecting the Auto Calibration type (Calibration Type).....	133
Enjoying high-fidelity sound (Pure Direct).....	134
Using Network Features.....	2
About network features.....	24
Overview of network features.....	135
Network features message list.....	136
Setting up a wired LAN connection (for wired LAN connections only).....	25
System requirements for a wired LAN connection.....	138
Connecting the receiver to the network using a LAN cable (for wired LAN connections only).....	103
Setting up a wired LAN connection.....	139
Setting up a wireless LAN connection (for wireless LAN connections only).....	26
System requirements for a wireless LAN connection.....	140
Connecting the receiver to the network using the wireless LAN antenna (for wireless LAN connections only).....	104
Selecting a wireless LAN connection method.....	141

Method 1: Setting up a wireless network using the WPS push button configuration method.....	142
Method 2: Setting up a wireless network using the WPS PIN code configuration method.....	143
Method 3: Setting up a network connection by selecting an access point (Access Point Scan method).....	144
Method 4: Setting up a network connection by adding a new access point (manual setup method).....	146
Enjoying audio content stored on a server on the home network (DLNA).....	27
Enjoying audio content stored on a server on the home network (DLNA).....	147
Deleting a server from the server list.....	149
Setting whether to control this receiver from a device on the home network (DLNA Control Permission).....	150
Enjoying audio content from iTunes or an iPhone/iPad/iPod via the network (AirPlay).....	28
Compatible iPhone/iPod/iPad models.....	112
Enjoying audio content from iTunes or an iPhone/iPad/iPod via the network (AirPlay).....	115
Enjoying internet music services.....	29
Enjoying music services offered on the Internet.....	151
Registering a new music service.....	153
Controlling the receiver using a smartphone or tablet device (TV SideView).....	30
Registering a TV SideView device to the receiver.....	154
Controlling the receiver using a smartphone or tablet device (SongPal).....	31
Controlling the receiver using a smartphone or tablet device (SongPal).....	155
Setting whether to control this receiver from a device on the home network.....	32
Setting control permissions to all devices on the home network (DLNA Control Permission).....	156
Setting whether to control this receiver from a device on the home network (DLNA Control Permission).....	150
Using BLUETOOTH Features.....	3
Enjoying audio content stored on a BLUETOOTH device.....	33
Compatible BLUETOOTH version and profiles.....	157
Turning the BLUETOOTH function on/off (Bluetooth Power).....	158
Enjoying audio content stored on a BLUETOOTH device with a one-touch connection (NFC).....	159
Enjoying audio content stored on a BLUETOOTH device.....	117
Controlling a BLUETOOTH device using the remote control.....	161
Using the Multi-Zone Features (for STR-DN1050 only).....	4
Enjoying sound in two rooms (multi-zone feature using the receiver with 2	

Enjoying sound in two rooms (multi-zone feature using the receiver with 2 pairs of speakers) (for STR-DN1050only).....	34
Connecting the speakers in zone 2 (for STR-DN1050 only).....	84
Setting the speakers for zone 2 (for STR-DN1050 only).....	162
Operating the receiver for zone 2 (for STR-DN1050 only).....	163
Enjoying sound in two rooms (multi-zone feature using the receiver and another amplifier) (for STR-DN1050 only).....	35
Connecting another amplifier in zone 2 (for STR-DN1050 only).....	101
Setting the volume control for zone 2 (Lineout) (for STR-DN1050 only).....	165
Setting the zone 2 HDMI output (Zone2 Out) (for STR-DN1050 only).....	166
Setting the priority for the main zone (Priority) (for STR-DN1050 only).....	167
Operating the receiver for zone 2 (for STR-DN1050 only).....	163
Using Other Features.....	5
Interlocking with BRAVIA TV and other devices (“BRAVIA” Sync)	36
What is “BRAVIA” Sync?	168
Preparing for “BRAVIA” Sync	169
Interlocking other devices using an HDMI connection (“BRAVIA” Sync)	170
Configuring video and sound settings.....	37
Enjoying sound of TV broadcasts from the receiver.....	171
Switching the monitors that output the HDMI video signals (for STR-DN1050 only).....	172
Switching between digital and analog audio (Input Mode).....	173
Using other video/audio input jacks (Input Assign).....	174
Saving and recalling various settings for the receiver (Custom Preset).....	38
About Custom Preset.....	176
Recalling the settings saved to the scene.....	177
Saving the settings to a preset.....	178
Items for which you can save settings and the default values for each item.....	179
Configuring speaker settings.....	39
Adjusting the sound balance automatically (Auto Calibration).....	181
Using bi-amplifier connections.....	182
Using the sleep timer.....	40
Using the sleep timer.....	183
Checking information on the receiver.....	41
Viewing information on the display panel.....	184
Adjusting Settings.....	6
Easy Setup.....	42
Setting up the receiver using the Easy Setup.....	108
Speaker Settings.....	43
Performing Auto Calibration.....	185

Calibrating the phase characteristics of the speakers (A.P.M. (Automatic Phase Matching)).....	187
Selecting the speaker pattern and setting the assignment for the speaker terminals (Speaker Connection/SBSpeaker Assign).....	188
Adjusting the speaker level (Level/Distance/Size).....	189
Adjusting the speaker distance (Level/Distance/Size).....	190
Setting the crossover frequency of the speakers (Crossover Frequency).....	192
Outputting a test tone from each speaker (Test Tone).....	193
Lifting up the sound of the center speaker (Center Speaker Lift Up).....	194
Selecting the unit of measurement (Distance Unit).....	195
Audio Settings.....	44
Playing audio signals with high-quality sound (Digital Legato Linear (D.L. L.)).....	196
Enjoying clear and dynamic sound at a low volume (Sound Optimizer).....	132
Adjusting the equalizer (Equalizer).....	131
Selecting a sound field (Sound Field).....	129
Enjoying high-fidelity sound (Pure Direct).....	134
Setting the low-pass filter for the subwoofer output (Subwoofer Low Pass Filter).....	197
Synchronizing audio with video output (A/V Sync).....	198
Adjusting the volume automatically (Advanced Auto Volume).....	199
Selecting the language of digital broadcasts (Dual Mono).....	200
Compressing the dynamic range (Dynamic Range Compressor).....	201
HDMI Settings.....	45
Up-converting video signals to 4K (4K Scaling).....	202
Controlling HDMI devices (Control for HDMI).....	203
Passing HDMI signals through (Pass Through).....	204
Setting the HDMI audio signal output of connected devices (Audio Out).....	205
Setting the level of the subwoofer (Subwoofer Level).....	206
Setting the zone 2 HDMI output (Zone2 Out) (for STR-DN1050 only).....	166
Setting the priority for the main zone (Priority) (for STR-DN1050 only).....	167
Speeding up the display when switching the HDMI input (Fast View).....	207
Automatically switching the input when an MHL device is played (MHL Auto Input).....	208
Input Settings.....	46
Changing the assignment and display for the input jacks.....	209
Changing the name for each input (Name).....	210
Network Settings.....	47
Turning on/off the Wi-Fi function (Wi-Fi).....	211
Setting up a network (Internet Setting).....	212

Checking the network information (Information).....	213
Assigning a name to the receiver (Device Name).....	214
Turning on the control mode for maintenance (External Control).....	215
Enabling the network function even when this receiver is in standby mode (Network Standby) (for USA and Canadian models only).....	216
Setting control permissions to all devices on the home network (DLNA Control Permission).....	156
Setting whether to control this receiver from a device on the home network (DLNA Control Permission).....	150
Checking registered TV SideView devices (TV SideView Setup).....	217
Bluetooth Settings.....	48
Turning the BLUETOOTH function on/off (Bluetooth Power).....	158
Bluetooth Pairing.....	218
Setting the Bluetooth Standby mode (Bluetooth Standby).....	219
Setting BLUETOOTH audio codecs (Bluetooth AAC/Bluetooth aptX).....	220
Zone Settings (for STR-DN1050 only).....	49
Turning on/off the power for zone 2 (Power) (for STR-DN1050 only).....	221
Selecting the source signals for zone 2 (Input) (for STR-DN1050 only).....	222
Adjusting the volume for zone 2 (Volume) (for STR-DN1050 only).....	223
Setting the volume control for zone 2 (Lineout) (for STR-DN1050 only).....	165
System Settings.....	50
Selecting the language (Language).....	224
Tuning on/off the display for the volume level or sound field (Auto Display).....	225
Setting standby mode (Auto Standby).....	226
Receiving information on newer software (Software Update Notification).....	227
Checking the software version (Software Version).....	228
Updating the software (Network Update).....	229
Using the menu on the display panel.....	51
Operating the receiver with the menu on the display panel.....	230
Viewing information on the display panel.....	184
Reverting to the factory default settings.....	52
Reverting to the factory default settings.....	231
Parts and Controls.....	7
Receiver.....	53
Front panel (STR-DN1050).....	232
Front panel (STR-DN850).....	234
Rear panel (STR-DN1050).....	236
Rear panel (STR-DN850).....	237
Indicators on the display panel.....	238
Remote control.....	54

Remote control.....	240
Announcements.....	8
Specifications.....	55
Specifications.....	242
Supplied accessories.....	74
Trademarks.....	56
Trademarks.....	249
Software License Information.....	57
Software License Information.....	251
Troubleshooting.....	9
Error messages.....	58
PROTECTOR.....	264
USB FAIL.....	265
List of messages after Auto Calibration measurements.....	266
iPhone/iPod message list.....	267
USB message list.....	268
Network features message list.....	136
Power.....	59
The receiver is turned off automatically.....	269
Image.....	60
No image appears on the TV.....	270
No 3D image appears on the TV.....	271
No 4K image appears on the TV.....	272
No image is output from the TV when the receiver is in standby mode.....	273
The GUI menu does not appear on the TV screen.....	274
The display panel is turned off.....	275
Sound.....	61
No sound or only a very low level of sound is heard, no matter which device is selected.....	276
There is severe humming or noise.....	277
No sound or only a very low level of sound is heard from specific speakers.....	278
There is no sound from a specific device.....	279
The left and right sound is unbalanced or reversed.....	281
Dolby Digital or DTS multi-channel sound is not reproduced.....	282
The surround effect cannot be obtained.....	283
A test tone is not output from the speakers.....	284
A test tone is output from a different speaker than the speaker displayed on the TV screen.....	285
No sound is output from the TV when the receiver is in standby mode.....	286

Tuner.....	62
The FM reception is poor.....	287
The FM stereo reception is poor.....	288
You cannot tune to radio stations.....	289
RDS does not work (for European and Australian models only).....	290
The RDS information that you want does not appear (for European and Australian models only).....	291
iPhone/iPod.....	63
The sound is distorted.....	292
There is no sound from an iPhone/iPod.....	293
An iPhone/iPod cannot be charged.....	294
An iPhone/iPod cannot be operated.....	295
The ringtone volume of an iPhone does not change.....	296
USB devices.....	64
Are you using a compatible USB device?.....	297
There is noise, skipping, or distorted sound.....	298
A USB device is not recognized.....	299
Playback does not start.....	300
A USB device cannot be connected to the USB port.....	301
Erroneous display.....	302
[Reading] is displayed for an extended time, or it takes a long time before playback starts.....	303
An audio file cannot be played.....	304
Network connection.....	65
Cannot connect to the network using WPS via a wireless LAN connection.....	305
An error message appears.....	306
Cannot connect to the network.....	307
Cannot control the receiver using a TV SideView device.....	308
Cannot select the Network Settings menu.....	309
Home network.....	66
Cannot connect to the network.....	310
A server does not appear in the server list. ([No server is available] appears on the TV screen.).....	311
Playback does not start, or does not automatically proceed to the next track or file.....	312
The sound skips during playback.....	313
[Cannot play] appears.....	314
[No Track] appears.....	315
Cannot play copyrighted files.....	316
Cannot select a previously selected track.....	317

Controller devices or applications on the home network cannot connect to the receiver.....	318
The receiver cannot be turned on by devices on a network.....	319
AirPlay.....	67
The receiver cannot be found from an iPhone/iPad/iPod or iTunes.....	320
The sound skips.....	321
The receiver cannot be operated.....	322
Music Services.....	68
Cannot connect the receiver to a service.....	323
The sound skips.....	324
BLUETOOTH device.....	69
Pairing cannot be done.....	325
Cannot make a BLUETOOTH connection.....	326
The sound skips or fluctuates, or the connection is lost.....	327
The sound of your BLUETOOTH device cannot be heard on the receiver.....	328
Severe humming or noise.....	329
“BRAVIA” Sync (Control for HDMI)	70
The Control for HDMI function does not work.....	330
The Audio Return Channel (ARC) function does not work.....	331
An MHL-compatible source device cannot be charged.....	332
No image from an MHL-compatible source device.....	333
Remote control.....	71
The remote control does not function.....	334
If the problem is not solved.....	72
Reverting to the factory default settings.....	231
Resetting sound fields to the default settings.....	130
Customer support websites.....	335



MULTI CHANNEL AV RECEIVER
STR-DN1050/STR-DN850

Enjoying Video and Sound

[Basic operations](#)



[Playing content from an iPhone/iPod](#)



[Playing content from a USB device](#)



[Listening to the radio](#)



[Enjoying sound effects](#)



[Notes on use](#)

4-488-938-11(1)

Copyright 2014 Sony Corporation



MULTI CHANNEL AV RECEIVER
STR-DN1050/STR-DN850

Using Network Features

[About network features](#)



[Setting up a wired LAN connection \(for wired LAN connections only\)](#)



[Setting up a wireless LAN connection \(for wireless LAN connections only\)](#)



[Enjoying audio content stored on a server on the home network \(DLNA\)](#)



[Enjoying audio content from iTunes or an iPhone/iPad/iPod via the network \(AirPlay\)](#)



[Enjoying internet music services](#)



[Controlling the receiver using a smartphone or tablet device \(TV SideView\)](#)



[Controlling the receiver using a smartphone or tablet device \(SongPal\)](#)



[Setting whether to control this receiver from a device on the home network](#)



Notes on use

4-488-938-11(1)

Copyright 2014 Sony Corporation



MULTI CHANNEL AV RECEIVER
STR-DN1050/STR-DN850

Using BLUETOOTH Features

[Enjoying audio content stored on a BLUETOOTH device](#)



[Notes on use](#)

4-488-938-11(1)

Copyright 2014 Sony Corporation



MULTI CHANNEL AV RECEIVER
STR-DN1050/STR-DN850

Using the Multi-Zone Features (for STR-DN1050 only)

[Enjoying sound in two rooms \(multi-zone feature using the receiver with 2 pairs of speakers\) \(for STR-DN1050 only\)](#) 

[Enjoying sound in two rooms \(multi-zone feature using the receiver and another amplifier\) \(for STR-DN1050 only\)](#) 

[Notes on use](#)

4-488-938-11(1)

Copyright 2014 Sony Corporation



MULTI CHANNEL AV RECEIVER
STR-DN1050/STR-DN850

Using Other Features

[Interlocking with BRAVIA TV and other devices \(“BRAVIA” Sync\)](#)



[Configuring video and sound settings](#)



[Saving and recalling various settings for the receiver \(Custom Preset\)](#)



[Configuring speaker settings](#)



[Using the sleep timer](#)



[Checking information on the receiver](#)



Notes on use

4-488-938-11(1)

Copyright 2014 Sony Corporation



MULTI CHANNEL AV RECEIVER
STR-DN1050/STR-DN850

Adjusting Settings

[Easy Setup](#) 

[Speaker Settings](#) 

[Audio Settings](#) 

[HDMI Settings](#) 

[Input Settings](#) 

[Network Settings](#) 

[Bluetooth Settings](#) 

[Zone Settings \(for STR-DN1050 only\)](#) 

[System Settings](#) 

[Using the menu on the display panel](#) 

[Reverting to the factory default settings](#) 

[Notes on use](#)

4-488-938-11(1)

Copyright 2014 Sony Corporation



MULTI CHANNEL AV RECEIVER
STR-DN1050/STR-DN850

Parts and Controls

[Receiver](#)



[Remote control](#)



[Notes on use](#)

4-488-938-11(1)

Copyright 2014 Sony Corporation



MULTI CHANNEL AV RECEIVER
STR-DN1050/STR-DN850

Announcements

[Specifications](#)



[Trademarks](#)



[Software License Information](#)



[Notes on use](#)

4-488-938-11(1)

Copyright 2014 Sony Corporation



MULTI CHANNEL AV RECEIVER
STR-DN1050/STR-DN850

Troubleshooting

[Error messages](#)



[Power](#)



[Image](#)



[Sound](#)



[Tuner](#)



[iPhone/iPod](#)



[USB devices](#)



[Network connection](#)



[Home network](#)



[AirPlay](#)



[Music Services](#)



[BLUETOOTH device](#)



[“BRAVIA” Sync \(Control for HDMI\)](#)



[Remote control](#)





[Notes on use](#)

4-488-938-11(1)

Copyright 2014 Sony Corporation



MULTI CHANNEL AV RECEIVER
STR-DN1050/STR-DN850

Notes on use

June 2013

Before use

To make full use of this content, please read the following notes thoroughly. Please note that they are subject to change without prior notice.

Recommended system environment

The following system environments are recommended for displaying this content. You may not be able to view the content on other system environments.

■ For viewing on a computer

Recommended browser

- With Microsoft Windows
 - Microsoft Internet Explorer 8 or later
 - Mozilla Firefox: latest version
 - Google Chrome™ : latest version
- With Apple Mac OS
 - Apple Safari Ver. 5 or later
 - Mozilla Firefox: latest version
 - Google Chrome : latest version

■ For viewing on a smartphone or tablet

Basic operation has been confirmed on the standard browser for the noted devices running the following operating systems.

- Android™ 2.3 or later: Xperia series, Walkman running Android
- iOS 4 or later: iPhone, iPod touch, iPad

■ JavaScript

JavaScript is used with this content for viewing convenience. If JavaScript is disabled in your web browser settings, the content may not operate properly or it may not be displayed correctly.

■ Style Sheets

Cascading Style Sheets are used in designing this content. Page layout may not be as intended if you view the content with style sheets disabled or on a web browser that is not compatible with style sheets. However, operation will not be affected.

■ Cookies

This content uses cookies. To use services incorporating cookies, you need to set your browser to allow cookies.

Handling of personal information obtained from websites

Sony may use cookies, web beacons or similar technologies to make statistical analysis of customers' usage of this content while preserving anonymity.

Notes on use

4-488-938-11(1)

Copyright 2014 Sony Corporation



MULTI CHANNEL AV RECEIVER
STR-DN1050/STR-DN850

Before using

[Procedure to start using the receiver](#)



[Supplied accessories](#)



[Function for conversion of video signals](#)



[Digital audio formats supported by the receiver](#)



[Notes on connecting cables](#)



[Using HDMI connections](#)



[Using MHL \(Mobile High-Definition Link\) connections](#)



[Notes on use](#)

4-488-938-11(1)

Copyright 2014 Sony Corporation



MULTI CHANNEL AV RECEIVER
STR-DN1050/STR-DN850

Installing and connecting speakers

[Installing speakers](#)



[Connecting speakers](#)



[Connecting the speakers in zone 2 \(for STR-DN1050 only\)](#)



[Notes on use](#)

4-488-938-11(1)

Copyright 2014 Sony Corporation



MULTI CHANNEL AV RECEIVER
STR-DN1050/STR-DN850

Connecting audio-visual devices and the antennas (aerials)

[Connecting a TV \(for STR-DN1050\)](#)



[Connecting a TV \(for STR-DN850\)](#)



[Connecting devices with HDMI jacks](#)



[Connecting devices with jacks other than HDMI jacks \(for STR-DN1050\)](#)



[Connecting devices with jacks other than HDMI jacks \(for STR-DN850\)](#)



[Connecting an iPhone, iPod, or USB device](#)



[Connecting an MHL-compatible mobile device](#)



[Connecting the antennas \(aerials\)](#)



[Connecting another amplifier in zone 2 \(for STR-DN1050 only\)](#)



[Notes on use](#)

4-488-938-11(1)

Copyright 2014 Sony Corporation



MULTI CHANNEL AV RECEIVER
STR-DN1050/STR-DN850

Connecting to the network

[Connecting the receiver to the network using a LAN cable \(for wired LAN connections only\)](#)



[Connecting the receiver to the network using the wireless LAN antenna \(for wireless LAN connections only\)](#)



[Notes on use](#)

4-488-938-11(1)

Copyright 2014 Sony Corporation



MULTI CHANNEL AV RECEIVER
STR-DN1050/STR-DN850

Turning on the receiver/preparing the remote control

[Setting the voltage selector](#)



[Inserting batteries into the remote control](#)



[Turning on the receiver](#)



[Notes on use](#)

4-488-938-11(1)

Copyright 2014 Sony Corporation



MULTI CHANNEL AV RECEIVER
STR-DN1050/STR-DN850

Initial setup of the receiver

[Setting up the receiver using the Easy Setup](#)



[Notes on use](#)

4-488-938-11(1)

Copyright 2014 Sony Corporation



MULTI CHANNEL AV RECEIVER
STR-DN1050/STR-DN850

Basic operations

[Using the menu on the TV screen](#)



[Enjoying video/sound from the connected device](#)



[Notes on use](#)

4-488-938-11(1)

Copyright 2014 Sony Corporation



MULTI CHANNEL AV RECEIVER
STR-DN1050/STR-DN850

Playing content from an iPhone/iPod

[Compatible iPhone/iPod/iPad models](#)



[Notes on iPhone/iPod](#)



[Enjoying audio content stored on an iPhone/iPod via the USB port](#)



[Enjoying audio content from iTunes or an iPhone/iPad/iPod via the network \(AirPlay\)](#)



[Enjoying audio content stored on a BLUETOOTH device](#)



[Notes on use](#)

4-488-938-11(1)

Copyright 2014 Sony Corporation



MULTI CHANNEL AV RECEIVER
STR-DN1050/STR-DN850

Playing content from a USB device

[Compatible USB devices and USB specifications](#)



[Notes on USB devices](#)



[Enjoying audio content stored on a USB device](#)



[Notes on use](#)

4-488-938-11(1)

Copyright 2014 Sony Corporation



MULTI CHANNEL AV RECEIVER
STR-DN1050/STR-DN850

Listening to the radio

[Listening to FM/AM radio](#)



[Presetting FM/AM radio stations \(Preset Memory\)](#)



[Tuning to a station directly \(Direct Tuning\)](#)



[Changing the AM tuning scale \(for USA, Canadian, and Mexican models only\)](#)



[Receiving RDS broadcasts \(for European and Australian models only\)](#)



[Notes on use](#)

4-488-938-11(1)

Copyright 2014 Sony Corporation



MULTI CHANNEL AV RECEIVER
STR-DN1050/STR-DN850

Enjoying sound effects

[Selecting a sound field \(Sound Field\)](#)



[Resetting sound fields to the default settings](#)



[Adjusting the equalizer \(Equalizer\)](#)



[Enjoying clear and dynamic sound at a low volume \(Sound Optimizer\)](#)



[Selecting the Auto Calibration type \(Calibration Type\)](#)



[Enjoying high-fidelity sound \(Pure Direct\)](#)



Notes on use

4-488-938-11(1)

Copyright 2014 Sony Corporation



MULTI CHANNEL AV RECEIVER
STR-DN1050/STR-DN850

About network features

[Overview of network features](#)



[Network features message list](#)



[Notes on use](#)

4-488-938-11(1)

Copyright 2014 Sony Corporation



MULTI CHANNEL AV RECEIVER
STR-DN1050/STR-DN850

Setting up a wired LAN connection (for wired LAN connections only)

[System requirements for a wired LAN connection](#)



[Connecting the receiver to the network using a LAN cable \(for wired LAN connections only\)](#)



[Setting up a wired LAN connection](#)



[Notes on use](#)

4-488-938-11(1)

Copyright 2014 Sony Corporation



MULTI CHANNEL AV RECEIVER
STR-DN1050/STR-DN850

Setting up a wireless LAN connection (for wireless LAN connections only)

[System requirements for a wireless LAN connection](#)



[Connecting the receiver to the network using the wireless LAN antenna \(for wireless LAN connections only\)](#)



[Selecting a wireless LAN connection method](#)



[Method 1: Setting up a wireless network using the WPS push button configuration method](#)



[Method 2: Setting up a wireless network using the WPS PIN code configuration method](#)



[Method 3: Setting up a network connection by selecting an access point \(Access Point Scan method\)](#)



[Method 4: Setting up a network connection by adding a new access point \(manual setup method\)](#)



[Notes on use](#)

4-488-938-11(1)

Copyright 2014 Sony Corporation



MULTI CHANNEL AV RECEIVER
STR-DN1050/STR-DN850

Enjoying audio content stored on a server on the home network (DLNA)

[Enjoying audio content stored on a server on the home network \(DLNA\)](#)



[Deleting a server from the server list](#)



[Setting whether to control this receiver from a device on the home network \(DLNA Control Permission\)](#)



[Notes on use](#)

4-488-938-11(1)

Copyright 2014 Sony Corporation



MULTI CHANNEL AV RECEIVER
STR-DN1050/STR-DN850

Enjoying audio content from iTunes or an iPhone/iPad/iPod via the network (AirPlay)

[Compatible iPhone/iPod/iPad models](#)



[Enjoying audio content from iTunes or an iPhone/iPad/iPod via the network \(AirPlay\)](#)



[Notes on use](#)

4-488-938-11(1)

Copyright 2014 Sony Corporation



MULTI CHANNEL AV RECEIVER
STR-DN1050/STR-DN850

Enjoying internet music services

[Enjoying music services offered on the Internet](#)



[Registering a new music service](#)



[Notes on use](#)

4-488-938-11(1)

Copyright 2014 Sony Corporation



MULTI CHANNEL AV RECEIVER
STR-DN1050/STR-DN850

Controlling the receiver using a smartphone or tablet device (TV SideView)

[Registering a TV SideView device to the receiver](#)



[Notes on use](#)

4-488-938-11(1)

Copyright 2014 Sony Corporation



MULTI CHANNEL AV RECEIVER
STR-DN1050/STR-DN850

Controlling the receiver using a smartphone or tablet device (SongPal)

[Controlling the receiver using a smartphone or tablet device \(SongPal\)](#)



[Notes on use](#)

4-488-938-11(1)

Copyright 2014 Sony Corporation



MULTI CHANNEL AV RECEIVER
STR-DN1050/STR-DN850

Setting whether to control this receiver from a device on the home network

[Setting control permissions to all devices on the home network \(DLNA Control Permission\)](#)



[Setting whether to control this receiver from a device on the home network \(DLNA Control Permission\)](#)



[Notes on use](#)

4-488-938-11(1)

Copyright 2014 Sony Corporation



MULTI CHANNEL AV RECEIVER
STR-DN1050/STR-DN850

Enjoying audio content stored on a BLUETOOTH device

[Compatible BLUETOOTH version and profiles](#)



[Turning the BLUETOOTH function on/off \(Bluetooth Power\)](#)



[Enjoying audio content stored on a BLUETOOTH device with a one-touch connection \(NFC\)](#)



[Enjoying audio content stored on a BLUETOOTH device](#)



[Controlling a BLUETOOTH device using the remote control](#)



[Notes on use](#)

4-488-938-11(1)

Copyright 2014 Sony Corporation



MULTI CHANNEL AV RECEIVER
STR-DN1050/STR-DN850

Enjoying sound in two rooms (multi-zone feature using the receiver with 2 pairs of speakers) (for STR-DN1050 only)

[Connecting the speakers in zone 2 \(for STR-DN1050 only\)](#)



[Setting the speakers for zone 2 \(for STR-DN1050 only\)](#)



[Operating the receiver for zone 2 \(for STR-DN1050 only\)](#)



[Notes on use](#)

4-488-938-11(1)

Copyright 2014 Sony Corporation



MULTI CHANNEL AV RECEIVER
STR-DN1050/STR-DN850

Enjoying sound in two rooms (multi-zone feature using the receiver and another amplifier) (for STR-DN1050 only)

[Connecting another amplifier in zone 2 \(for STR-DN1050 only\)](#)



[Setting the volume control for zone 2 \(Lineout\) \(for STR-DN1050 only\)](#)



[Setting the zone 2 HDMI output \(Zone2 Out\) \(for STR-DN1050 only\)](#)



[Setting the priority for the main zone \(Priority\) \(for STR-DN1050 only\)](#)



[Operating the receiver for zone 2 \(for STR-DN1050 only\)](#)



[Notes on use](#)

4-488-938-11(1)

Copyright 2014 Sony Corporation



MULTI CHANNEL AV RECEIVER
STR-DN1050/STR-DN850

Interlocking with BRAVIA TV and other devices (“BRAVIA” Sync)

[What is “BRAVIA” Sync?](#)



[Preparing for “BRAVIA” Sync](#)



[Interlocking other devices using an HDMI connection \(“BRAVIA” Sync\)](#)



[Notes on use](#)

4-488-938-11(1)

Copyright 2014 Sony Corporation



MULTI CHANNEL AV RECEIVER
STR-DN1050/STR-DN850

Configuring video and sound settings

[Enjoying sound of TV broadcasts from the receiver](#)



[Switching the monitors that output the HDMI video signals \(for STR-DN1050 only\)](#)



[Switching between digital and analog audio \(Input Mode\)](#)



[Using other video/audio input jacks \(Input Assign\)](#)



[Notes on use](#)

4-488-938-11(1)

Copyright 2014 Sony Corporation



MULTI CHANNEL AV RECEIVER
STR-DN1050/STR-DN850

Saving and recalling various settings for the receiver (Custom Preset)

[About Custom Preset](#)



[Recalling the settings saved to the scene](#)



[Saving the settings to a preset](#)



[Items for which you can save settings and the default values for each item](#)



[Notes on use](#)

4-488-938-11(1)

Copyright 2014 Sony Corporation



MULTI CHANNEL AV RECEIVER
STR-DN1050/STR-DN850

Configuring speaker settings

[Adjusting the sound balance automatically \(Auto Calibration\)](#)



[Using bi-amplifier connections](#)



[Notes on use](#)

4-488-938-11(1)

Copyright 2014 Sony Corporation



MULTI CHANNEL AV RECEIVER
STR-DN1050/STR-DN850

Using the sleep timer

[Using the sleep timer](#)



[Notes on use](#)

4-488-938-11(1)

Copyright 2014 Sony Corporation



MULTI CHANNEL AV RECEIVER
STR-DN1050/STR-DN850

Checking information on the receiver

[Viewing information on the display panel](#)



[Notes on use](#)

4-488-938-11(1)

Copyright 2014 Sony Corporation



MULTI CHANNEL AV RECEIVER
STR-DN1050/STR-DN850

Easy Setup

[Setting up the receiver using the Easy Setup](#)



[Notes on use](#)

4-488-938-11(1)

Copyright 2014 Sony Corporation

MULTI CHANNEL AV RECEIVER
STR-DN1050/STR-DN850

Speaker Settings

[Performing Auto Calibration](#) 

[Calibrating the phase characteristics of the speakers \(A.P.M. \(Automatic Phase Matching\)\)](#) 

[Selecting the Auto Calibration type \(Calibration Type\)](#) 

[Selecting the speaker pattern and setting the assignment for the speaker terminals \(Speaker Connection/SB Speaker Assign\)](#) 

[Adjusting the speaker level \(Level/Distance/Size\)](#) 

[Adjusting the speaker distance \(Level/Distance/Size\)](#) 

[Adjusting the speaker size \(Level/Distance/Size\)](#) 

[Setting the crossover frequency of the speakers \(Crossover Frequency\)](#) 

[Outputting a test tone from each speaker \(Test Tone\)](#) 

[Lifting up the sound of the center speaker \(Center Speaker Lift Up\)](#) 

[Selecting the unit of measurement \(Distance Unit\)](#) 

[Notes on use](#)

4-488-938-11(1)

Copyright 2014 Sony Corporation

MULTI CHANNEL AV RECEIVER
STR-DN1050/STR-DN850

Audio Settings

[Playing audio signals with high-quality sound \(Digital Legato Linear \(D.L.L.\)\)](#) 

[Enjoying clear and dynamic sound at a low volume \(Sound Optimizer\)](#) 

[Adjusting the equalizer \(Equalizer\)](#) 

[Selecting a sound field \(Sound Field\)](#) 

[Enjoying high-fidelity sound \(Pure Direct\)](#) 

[Setting the low-pass filter for the subwoofer output \(Subwoofer Low Pass Filter\)](#) 

[Synchronizing audio with video output \(A/V Sync\)](#) 

[Adjusting the volume automatically \(Advanced Auto Volume\)](#) 

[Selecting the language of digital broadcasts \(Dual Mono\)](#) 

[Compressing the dynamic range \(Dynamic Range Compressor\)](#) 

Notes on use

4-488-938-11(1)

Copyright 2014 Sony Corporation



MULTI CHANNEL AV RECEIVER
STR-DN1050/STR-DN850

HDMI Settings

[Up-converting video signals to 4K \(4K Scaling\)](#)



[Controlling HDMI devices \(Control for HDMI\)](#)



[Passing HDMI signals through \(Pass Through\)](#)



[Setting the HDMI audio signal output of connected devices \(Audio Out\)](#)



[Setting the level of the subwoofer \(Subwoofer Level\)](#)



[Setting the zone 2 HDMI output \(Zone2 Out\) \(for STR-DN1050 only\)](#)



[Setting the priority for the main zone \(Priority\) \(for STR-DN1050 only\)](#)



[Speeding up the display when switching the HDMI input \(Fast View\)](#)



[Automatically switching the input when an MHL device is played \(MHL Auto Input\)](#)



[Notes on use](#)

4-488-938-11(1)

Copyright 2014 Sony Corporation



MULTI CHANNEL AV RECEIVER
STR-DN1050/STR-DN850

Input Settings

[Changing the assignment and display for the input jacks](#)



[Changing the name for each input \(Name\)](#)



[Notes on use](#)

4-488-938-11(1)

Copyright 2014 Sony Corporation



MULTI CHANNEL AV RECEIVER
STR-DN1050/STR-DN850

Network Settings

[Turning on/off the Wi-Fi function \(Wi-Fi\)](#)



[Setting up a network \(Internet Setting\)](#)



[Checking the network information \(Information\)](#)



[Assigning a name to the receiver \(Device Name\)](#)



[Turning on the control mode for maintenance \(External Control\)](#)



[Enabling the network function even when this receiver is in standby mode \(Network Standby\) \(for USA and Canadian models only\)](#)



[Setting control permissions to all devices on the home network \(DLNA Control Permission\)](#)



[Setting whether to control this receiver from a device on the home network \(DLNA Control Permission\)](#)



[Checking registered TV SideView devices \(TV SideView Setup\)](#)



Notes on use

4-488-938-11(1)

Copyright 2014 Sony Corporation



MULTI CHANNEL AV RECEIVER
STR-DN1050/STR-DN850

Bluetooth Settings

[Turning the BLUETOOTH function on/off \(Bluetooth Power\)](#)



[Bluetooth Pairing](#)



[Setting the Bluetooth Standby mode \(Bluetooth Standby\)](#)



[Setting BLUETOOTH audio codecs \(Bluetooth AAC/Bluetooth aptX\)](#)



[Notes on use](#)

4-488-938-11(1)

Copyright 2014 Sony Corporation



MULTI CHANNEL AV RECEIVER
STR-DN1050/STR-DN850

Zone Settings (for STR-DN1050 only)

[Turning on/off the power for zone 2 \(Power\) \(for STR-DN1050 only\)](#)



[Selecting the source signals for zone 2 \(Input\) \(for STR-DN1050 only\)](#)



[Adjusting the volume for zone 2 \(Volume\) \(for STR-DN1050 only\)](#)



[Setting the volume control for zone 2 \(Lineout\) \(for STR-DN1050 only\)](#)



[Notes on use](#)

4-488-938-11(1)

Copyright 2014 Sony Corporation



MULTI CHANNEL AV RECEIVER
STR-DN1050/STR-DN850

System Settings

[Selecting the language \(Language\)](#)



[Tuning on/off the display for the volume level or sound field \(Auto Display\)](#)



[Setting standby mode \(Auto Standby\)](#)



[Receiving information on newer software \(Software Update Notification\)](#)



[Checking the software version \(Software Version\)](#)



[Updating the software \(Network Update\)](#)



[Notes on use](#)

4-488-938-11(1)

Copyright 2014 Sony Corporation



MULTI CHANNEL AV RECEIVER
STR-DN1050/STR-DN850

Using the menu on the display panel

[Operating the receiver with the menu on the display panel](#)



[Viewing information on the display panel](#)



[Notes on use](#)

4-488-938-11(1)

Copyright 2014 Sony Corporation



MULTI CHANNEL AV RECEIVER
STR-DN1050/STR-DN850

Reverting to the factory default settings

[Reverting to the factory default settings](#)



[Notes on use](#)

4-488-938-11(1)

Copyright 2014 Sony Corporation



MULTI CHANNEL AV RECEIVER
STR-DN1050/STR-DN850

Receiver

[Front panel \(STR-DN1050\)](#)



[Front panel \(STR-DN850\)](#)



[Rear panel \(STR-DN1050\)](#)



[Rear panel \(STR-DN850\)](#)



[Indicators on the display panel](#)



[Notes on use](#)

4-488-938-11(1)

Copyright 2014 Sony Corporation



MULTI CHANNEL AV RECEIVER
STR-DN1050/STR-DN850

Remote control

[Remote control](#)



[Notes on use](#)

4-488-938-11(1)

Copyright 2014 Sony Corporation



MULTI CHANNEL AV RECEIVER
STR-DN1050/STR-DN850

Specifications

[Specifications](#)



[Supplied accessories](#)



[Notes on use](#)

4-488-938-11(1)

Copyright 2014 Sony Corporation



MULTI CHANNEL AV RECEIVER
STR-DN1050/STR-DN850

Trademarks

[Trademarks](#)



[Notes on use](#)

4-488-938-11(1)

Copyright 2014 Sony Corporation



MULTI CHANNEL AV RECEIVER
STR-DN1050/STR-DN850

Software License Information

[Software License Information](#)



[Notes on use](#)

4-488-938-11(1)

Copyright 2014 Sony Corporation



MULTI CHANNEL AV RECEIVER
STR-DN1050/STR-DN850

Error messages

[PROTECTOR](#)



[USB FAIL](#)



[List of messages after Auto Calibration measurements](#)



[iPhone/iPod message list](#)



[USB message list](#)



[Network features message list](#)



[Notes on use](#)

4-488-938-11(1)

Copyright 2014 Sony Corporation



MULTI CHANNEL AV RECEIVER
STR-DN1050/STR-DN850

Power

[The receiver is turned off automatically.](#)



[Notes on use](#)

4-488-938-11(1)

Copyright 2014 Sony Corporation



MULTI CHANNEL AV RECEIVER
STR-DN1050/STR-DN850

Image

No image appears on the TV.



No 3D image appears on the TV.



No 4K image appears on the TV.



No image is output from the TV when the receiver is in standby mode.



The GUI menu does not appear on the TV screen.



The display panel is turned off.



Notes on use

4-488-938-11(1)

Copyright 2014 Sony Corporation



MULTI CHANNEL AV RECEIVER
STR-DN1050/STR-DN850

Sound

No sound or only a very low level of sound is heard, no matter which device is selected.



There is severe humming or noise.



No sound or only a very low level of sound is heard from specific speakers.



There is no sound from a specific device.



The left and right sound is unbalanced or reversed.



Dolby Digital or DTS multi-channel sound is not reproduced.



The surround effect cannot be obtained.



A test tone is not output from the speakers.



A test tone is output from a different speaker than the speaker displayed on the TV screen.



No sound is output from the TV when the receiver is in standby mode.



Notes on use

4-488-938-11(1)

Copyright 2014 Sony Corporation



MULTI CHANNEL AV RECEIVER
STR-DN1050/STR-DN850

Tuner

The FM reception is poor.



The FM stereo reception is poor.



You cannot tune to radio stations.



RDS does not work (for European and Australian models only).



The RDS information that you want does not appear (for European and Australian models only).



Notes on use

4-488-938-11(1)

Copyright 2014 Sony Corporation



MULTI CHANNEL AV RECEIVER
STR-DN1050/STR-DN850

iPhone/iPod

[The sound is distorted.](#)



[There is no sound from an iPhone/iPod.](#)



[An iPhone/iPod cannot be charged.](#)



[An iPhone/iPod cannot be operated.](#)



[The ringtone volume of an iPhone does not change.](#)



[Notes on use](#)

4-488-938-11(1)

Copyright 2014 Sony Corporation



MULTI CHANNEL AV RECEIVER
STR-DN1050/STR-DN850

USB devices

[Are you using a compatible USB device?](#)



[There is noise, skipping, or distorted sound.](#)



[A USB device is not recognized.](#)



[Playback does not start.](#)



[A USB device cannot be connected to the USB port.](#)



[Erroneous display.](#)



[\[Reading\] is displayed for an extended time, or it takes a long time before playback starts.](#)



[An audio file cannot be played.](#)



[Notes on use](#)

4-488-938-11(1)

Copyright 2014 Sony Corporation



MULTI CHANNEL AV RECEIVER
STR-DN1050/STR-DN850

Network connection

[Cannot connect to the network using WPS via a wireless LAN connection.](#)



[An error message appears.](#)



[Cannot connect to the network.](#)



[Cannot control the receiver using a TV SideView device.](#)



[Cannot select the Network Settings menu.](#)



[Notes on use](#)

4-488-938-11(1)

Copyright 2014 Sony Corporation



MULTI CHANNEL AV RECEIVER
STR-DN1050/STR-DN850

Home network

Cannot connect to the network.



A server does not appear in the server list. ([No server is available] appears on the TV screen.)



Playback does not start, or does not automatically proceed to the next track or file.



The sound skips during playback.



[Cannot play] appears.



[No Track] appears.



Cannot play copyrighted files.



Cannot select a previously selected track.



Controller devices or applications on the home network cannot connect to the receiver.



The receiver cannot be turned on by devices on a network.



Notes on use

4-488-938-11(1)

Copyright 2014 Sony Corporation



MULTI CHANNEL AV RECEIVER
STR-DN1050/STR-DN850

AirPlay

The receiver cannot be found from an iPhone/iPad/iPod or iTunes.



The sound skips.



The receiver cannot be operated.



Notes on use

4-488-938-11(1)

Copyright 2014 Sony Corporation



MULTI CHANNEL AV RECEIVER
STR-DN1050/STR-DN850

Music Services

[Cannot connect the receiver to a service.](#)



[The sound skips.](#)



[Notes on use](#)

4-488-938-11(1)

Copyright 2014 Sony Corporation



MULTI CHANNEL AV RECEIVER
STR-DN1050/STR-DN850

BLUETOOTH device

Pairing cannot be done.



Cannot make a BLUETOOTH connection.



The sound skips or fluctuates, or the connection is lost.



The sound of your BLUETOOTH device cannot be heard on the receiver.



Severe humming or noise.



Notes on use

4-488-938-11(1)

Copyright 2014 Sony Corporation



MULTI CHANNEL AV RECEIVER
STR-DN1050/STR-DN850

“BRAVIA” Sync (Control for HDMI)

The Control for HDMI function does not work.



The Audio Return Channel (ARC) function does not work.



An MHL-compatible source device cannot be charged.



No image from an MHL-compatible source device.



Notes on use

4-488-938-11(1)

Copyright 2014 Sony Corporation



MULTI CHANNEL AV RECEIVER
STR-DN1050/STR-DN850

Remote control

[The remote control does not function.](#)



[Notes on use](#)

4-488-938-11(1)

Copyright 2014 Sony Corporation



MULTI CHANNEL AV RECEIVER
STR-DN1050/STR-DN850

If the problem is not solved

[Reverting to the factory default settings](#)



[Resetting sound fields to the default settings](#)



[Customer support websites](#)



[Notes on use](#)

4-488-938-11(1)

Copyright 2014 Sony Corporation



MULTI CHANNEL AV RECEIVER
STR-DN1050/STR-DN850

Procedure to start using the receiver

See the following topics in this order to start using the receiver properly.

1. [Installing speakers](#)
2. [Connecting speakers](#)
3. [Connecting a TV \(for STR-DN1050\)/Connecting a TV \(for STR-DN850\)](#)
4. [Connecting devices with HDMI jacks](#)
5. [Connecting devices with jacks other than HDMI jacks \(for STR-DN1050\)/Connecting devices with jacks other than HDMI jacks \(for STR-DN850\)](#)
6. [Connecting the receiver to the network](#)
 - [Connecting the receiver to the network using a LAN cable \(for wired LAN connections only\)](#)
 - [Connecting the receiver to the network using the wireless LAN antenna \(for wireless LAN connections only\)](#)
7. [Inserting batteries into the remote control](#)
8. [Turning on the receiver](#)
9. [Setting up the receiver using the Easy Setup](#)

Notes on use

4-488-938-11(1)

Copyright 2014 Sony Corporation



MULTI CHANNEL AV RECEIVER
STR-DN1050/STR-DN850

Supplied accessories

- Startup Guide (1)
- Reference Guide (1)
- Remote control (1)
- R03 (size AAA) batteries (2)
- FM wire antenna (aerial) (1)



- AM loop antenna (aerial) (1)



- Optimizer microphone (1)



[Notes on use](#)

4-488-938-11(1)

Copyright 2014 Sony Corporation



MULTI CHANNEL AV RECEIVER
STR-DN1050/STR-DN850

Function for conversion of video signals

The receiver is equipped with a function for converting video signals. Video signals and component video signals can be output as HDMI video signals (*1).

The correspondence of the INPUT jacks to the OUTPUT jacks is shown below.

- HDMI IN: HDMI OUT
- COMPONENT VIDEO IN (for STR-DN1050 only): HDMI OUT (*1), COMPONENT VIDEO MONITOR OUT (*2)
- VIDEO IN: HDMI OUT (*1), MONITOR OUT (*2)

*1 For STR-DN1050 only. Video signals are upconverted when output (up to 4K).

*2 The same type of signal as the input signal is output.

Note

- When video signals from a VCR, etc., are upconverted on this receiver and then viewed on your TV, the image on the TV screen may appear distorted horizontally or no image may be seen depending on the status of the video signal output.
- If you are using image improvement circuitry with your VCR, it may impact the video signal conversion. It is recommended that you turn off this function on your VCR.
- Converted HDMI image output does not support “x.v.Color (x.v.Colour),” Deep Color (Deep Colour), or 3D.
- HDMI video signals cannot be converted to component video signals or video signals.
- 1080p component video signals cannot be upconverted.
- When [4K Scaling] is set to [Auto], if the HDMI input signals are 1080p@23.98/24 Hz and a 4K-compatible TV is connected, the HDMI input signals are automatically upscaled to 4K images and output from the HDMI OUT jack.

Notes on use

4-488-938-11(1)

Copyright 2014 Sony Corporation



MULTI CHANNEL AV RECEIVER
STR-DN1050/STR-DN850

Digital audio formats supported by the receiver

The digital audio formats that this receiver can decode depend on the digital audio output jacks of the connected device. This receiver supports the following audio formats. The words in brackets are those indicated on the display panel.

Dolby Digital [DOLBY D]

Maximum number of channels: 5.1

Connection with the receiver: COAXIAL/OPTICAL, HDMI (*2)

Dolby Digital EX [DOLBY EX]

Maximum number of channels: 6.1

Connection with the receiver: COAXIAL/OPTICAL, HDMI (*2)

Dolby Digital Plus [DOLBY D +] (*1)

Maximum number of channels: 7.1

Connection with the receiver: HDMI (*2)

Dolby TrueHD [DOLBY HD] (*1)

Maximum number of channels: 7.1

Connection with the receiver: HDMI

DTS [DTS]

Maximum number of channels: 5.1

Connection with the receiver: COAXIAL/OPTICAL, HDMI (*2)

DTS-ES Discrete [DTS-ES Dsc]

Maximum number of channels: 6.1

Connection with the receiver: COAXIAL/OPTICAL, HDMI (*2)

DTS-ES Matrix [DTS-ES Mtx]

Maximum number of channels: 6.1

Connection with the receiver: COAXIAL/OPTICAL, HDMI (*2)

DTS 96/24 [DTS 96/24]

Maximum number of channels: 5.1

Connection with the receiver: COAXIAL/OPTICAL, HDMI (*2)

DTS-HD High Resolution Audio [DTS-HD HR] (*1)

Maximum number of channels: 7.1

Connection with the receiver: HDMI (*2)

DTS-HD Master Audio [DTS-HD MA] (*1)

Maximum number of channels: 7.1

Connection with the receiver: HDMI

DSD [DSD] (*1)

Maximum number of channels: 5.1

Connection with the receiver: HDMI

Multi Channel Linear PCM (*1) [PCM]

Maximum number of channels: 7.1

Connection with the receiver: HDMI (*2)

*1 Audio signals are output in another format if the playback device does not correspond to the actual format. For details, refer to the operating instructions of the playback device.

*2 These formats are compatible with MHL when you connect a MHL-compatible source device to the HDMI/MHL (VIDEO 2 IN) (for STR-DN1050 only), HDMI VIDEO 1 IN (MHL) (for STR-DN1050 only) or HDMI VIDEO IN (MHL) (for STR-DN850 only) jack.

Notes on use

4-488-938-11(1)

Copyright 2014 Sony Corporation



MULTI CHANNEL AV RECEIVER
STR-DN1050/STR-DN850

Notes on connecting cables

- Be sure to disconnect the AC power cord (mains lead) before connecting cables.
- It is not necessary to connect all of the cables. Connect cables according to the availability of jacks on the connected device.
- Use a High Speed HDMI cable. 1080p, Deep Color (Deep Colour), 4K or 3D images may not be displayed properly if you use a Standard HDMI cable.
- We do not recommend using an HDMI-DVI conversion cable. If you connect an HDMI-DVI conversion cable to a DVI-D device, the sound and/or image may be lost. Connect separate audio cables or digital connecting cables, then reassign the input jacks if the sound is not output correctly. For details, see [“Using other video/audio input jacks \(Input Assign\).”](#)
- When connecting optical digital cables, insert the plugs straight until they click into place.
- Do not bend or tie optical digital cables.

Hint

- All of the digital audio jacks are compatible with 32 kHz, 44.1 kHz, 48 kHz, and 96 kHz sampling frequencies.

If you want to connect several digital devices, but cannot find an unused input

See [“Using other video/audio input jacks \(Input Assign\).”](#)

[Notes on use](#)

4-488-938-11(1)

Copyright 2014 Sony Corporation



MULTI CHANNEL AV RECEIVER
STR-DN1050/STR-DN850

Using HDMI connections

High-Definition Multimedia Interface (HDMI) is an interface that transmits video and audio signals in digital format. Connecting Sony “BRAVIA” Sync-compatible devices using HDMI cables simplifies operations. See “[Interlocking other devices using an HDMI connection \(“BRAVIA” Sync\).](#)”

HDMI features

- Digital audio signals transmitted by HDMI can be output from the speakers connected to the receiver. This signal supports Dolby Digital, DTS, DSD, and Linear PCM. For details, see “[Digital audio formats supported by the receiver.](#)”
- The receiver can receive Multi Channel Linear PCM (up to 8 channels) with a sampling frequency of 192 kHz or less via an HDMI connection.
- Analog video signals input to the receiver’s VIDEO jack or COMPONENT VIDEO jacks can be output as HDMI signals (for STR-DN1050 only). Audio signals are not output from the HDMI OUT jack(s) while the image is being converted.
- This receiver supports High Bitrate Audio (DTS-HD Master Audio, Dolby TrueHD), Deep Color (Deep Colour), “x.v.Color (x.v.Colour),” and 4K or 3D transmission.
- To enjoy 3D images, connect a 3D-compatible TV and video device (Blu-ray Disc player, Blu-ray Disc recorder, PlayStation 3, etc.) to the receiver using High Speed HDMI cables, put on 3D glasses, and then play 3D-compatible content.
- To enjoy 4K (HDMI BD/DVD, GAME, SAT/CATV, VIDEO1) images, connect a 4K-compatible TV or video device (Blu-ray Disc player, etc.) to the receiver using High Speed HDMI cables, and then play 4K-compatible content (for STR-DN1050 only).

Note

- Depending on the TV or video device, 4K or 3D images may not be displayed. Check the HDMI video formats supported by the receiver.
- Refer to the operating instructions of each connected device for details.

Notes on use

4-488-938-11(1)

Copyright 2014 Sony Corporation

MULTI CHANNEL AV RECEIVER
STR-DN1050/STR-DN850

Using MHL (Mobile High-Definition Link) connections

MHL (Mobile High-Definition Link) is an HD video and digital audio interface for connecting mobile phones and portable devices to HDTVs and other home entertainment products. MHL can support 1080p HD video and digital audio signals and supply power to the mobile device simultaneously. It also enables the remotes of TV and other home entertainment products to control the mobile phone and access its content.

Note

- MHL-compatible mobile devices are charged when connected to the HDMI/MHL (VIDEO 2 IN) (*1), HDMI VIDEO 1 IN (MHL) (*1) or HDMI VIDEO IN (MHL) (*2) jacks of the receiver while the receiver is turned on, or while the receiver is turned off when [Pass Through] is set to [On] (*3) or [Auto], or [Network Standby] (*4) is set to [On].

*1 For STR-DN1050 only

*2 For STR-DN850 only

*3 For USA, Canadian, Mexican, and Australian models only

*4 For USA and Canadian models only

Related Topic

- [Changing the name for each input \(Name\)](#)

Notes on use

4-488-938-11(1)

Copyright 2014 Sony Corporation



MULTI CHANNEL AV RECEIVER
STR-DN1050/STR-DN850

Installing speakers

This receiver allows you to use up to a 7.2-channel system (7 speakers and two subwoofers). Typical examples of speaker system configurations are as follows.

[5.1-channel speaker system](#)

To fully enjoy theater-like multi-channel surround sound, you need five speakers (two front speakers, a center speaker, and two surround speakers) and a subwoofer.

[7.1-channel speaker system using surround back speakers](#)

You can enjoy high-fidelity reproduction of recorded sound from a DVD or Blu-ray Disc in 6.1-channel or 7.1-channel format.

[7.1-channel speaker system using front high speakers](#)

You can enjoy vertical sound effects by connecting an additional two front high speakers.

Note

- You cannot use the surround back speakers and the front high speakers simultaneously.

Related Topic

- [Connecting speakers](#)
- [Connecting the speakers in zone 2 \(for STR-DN1050 only\)](#)
- [Connecting another amplifier in zone 2 \(for STR-DN1050 only\)](#)

[Notes on use](#)

4-488-938-11(1)

Copyright 2014 Sony Corporation

MULTI CHANNEL AV RECEIVER
STR-DN1050/STR-DN850

Connecting speakers

Connect each speaker as illustrated below.

Be sure to disconnect the AC power cord (mains lead) before connecting cables.

For details on how to connect speaker cables to the receiver, see “[How to connect speaker cables.](#)”

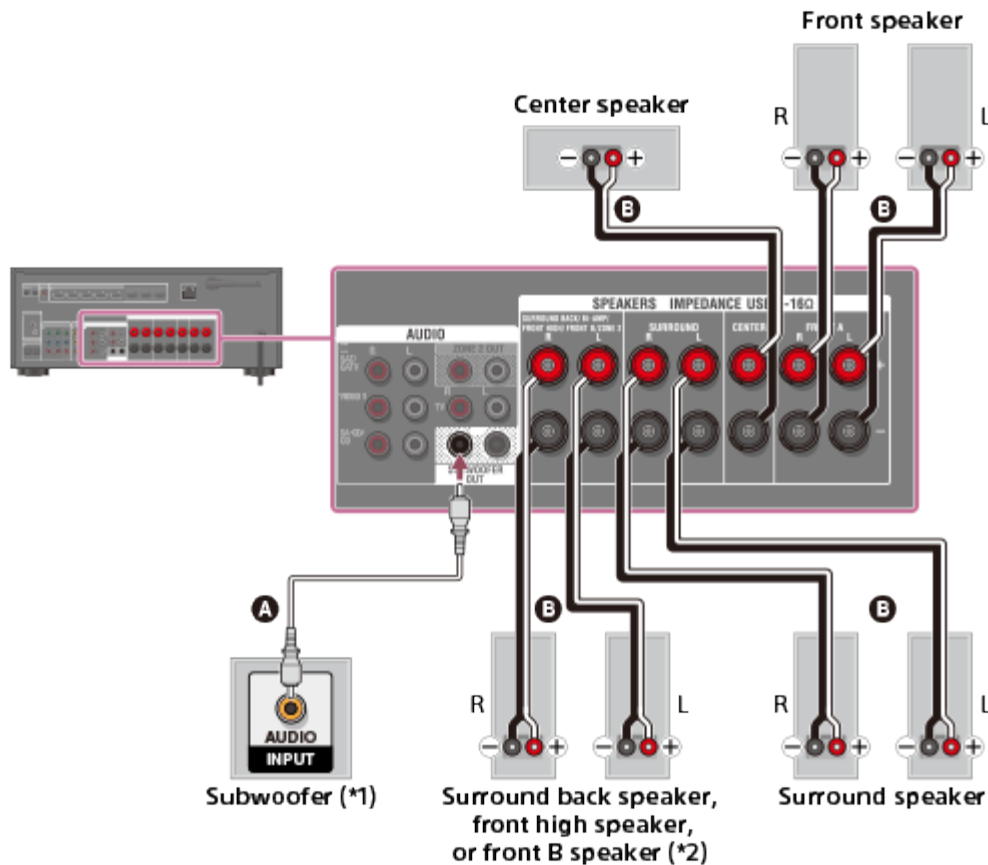

A Monaural audio cable (not supplied)

B Speaker cable (not supplied)

*1 If you connect a subwoofer with an auto standby function, turn off this function when watching movies. If the auto standby function is turned on, it switches to standby mode automatically based on the level of the input signal to the subwoofer, and the sound may not be output.

*2 Notes on connections to the SPEAKERS SURROUND BACK/BI-AMP/FRONT HIGH/FRONT B terminals

- If connecting only one surround back speaker, connect it to the L (+/-) terminals.
- If you have an additional front speaker system, connect it to these terminals. In this case, perform the following procedure:

1. Select [Speaker Connection] in the Speaker Settings menu, then select a speaker pattern that does not have surround back and front high speakers.

2. Set [SB Speaker Assign] in the Speaker Settings menu to [Front B].

You can select the front speaker system you want by using the SPEAKERS button on the receiver.

- You can connect the front speakers to this terminal using a bi-amplifier connection. In this case, set [SB Speaker Assign] in the Speaker Settings menu to [Bi-Amp].

Note

- After you have installed and connected your speakers, be sure to select the speaker pattern you want using [Speaker Connection] in the Speaker Settings menu.

Related Topic

- [Notes on connecting cables](#)
- [Using bi-amplifier connections](#)
- [Connecting the speakers in zone 2 \(for STR-DN1050 only\)](#)
- [Connecting another amplifier in zone 2 \(for STR-DN1050 only\)](#)
- [Selecting the speaker pattern and setting the assignment for the speaker terminals \(Speaker Connection/SB Speaker Assign\)](#)

[Notes on use](#)

4-488-938-11(1)

Copyright 2014 Sony Corporation

MULTI CHANNEL AV RECEIVER
STR-DN1050/STR-DN850

Connecting the speakers in zone 2 (for STR-DN1050 only)

You can enjoy sound from a device connected to the receiver in a zone other than the main zone. For example, you can watch a DVD in the main zone and listen to a CD in zone 2.

Connect each speaker as illustrated below.

Be sure to disconnect the AC power cord (mains lead) before connecting cables. For details on how to connect speaker cables to the receiver, see [“How to connect speaker cables.”](#)

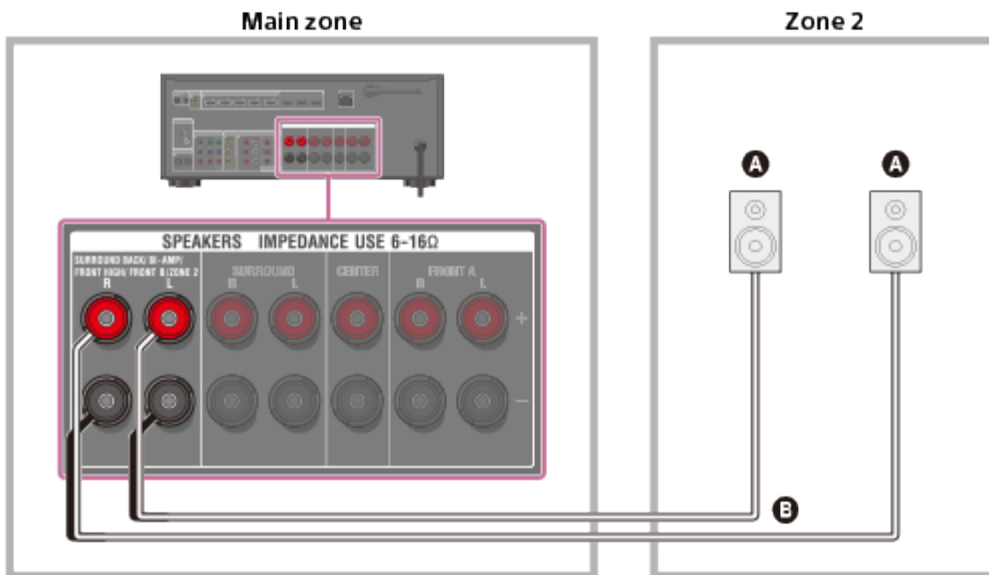

- Ⓐ Speakers
- Ⓑ Speaker cable (not supplied)

Note

- When using this zone 2 connection, you need to set up the SPEAKERS SURROUND BACK/BI-AMP/Front HIGH/Front B/ZONE 2 terminals. For details, see [“Setting the speakers for zone 2 \(for STR-DN1050 only\).”](#)

Related Topic

[Notes on connecting cables](#)

Notes on use

4-488-938-11(1)

Copyright 2014 Sony Corporation

MULTI CHANNEL AV RECEIVER
STR-DN1050/STR-DN850

Connecting a TV (for STR-DN1050)

Connect a TV to the HDMI OUT or MONITOR OUT jack. You can operate this receiver using a GUI (Graphical User Interface). GUI is used only for HDMI OUT A and HDMI OUT B.

Be sure to disconnect the AC power cord (mains lead) before connecting cables.

Connecting a TV compatible with the Audio Return Channel (ARC) function via an HDMI connection

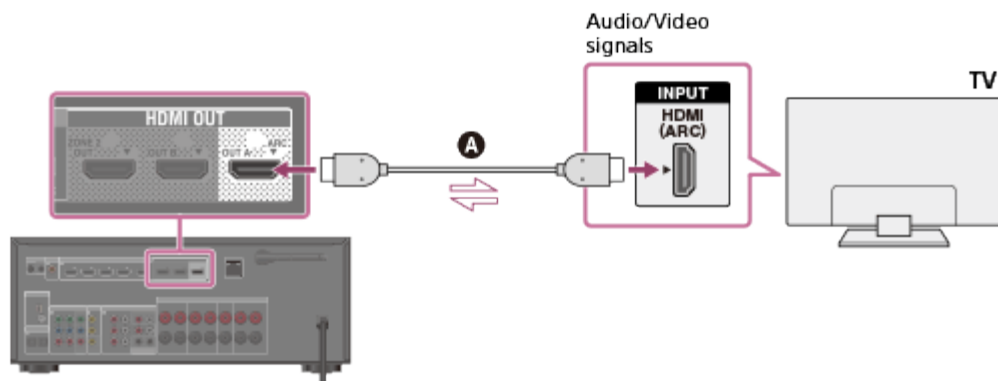

A HDMI cable (not supplied)

Sony recommends that you use an HDMI-authorized cable or HDMI cable made by Sony.

Connecting a TV incompatible with the Audio Return Channel (ARC) function via an HDMI connection

The solid lines show recommended connections and the dashed lines show alternative connections.

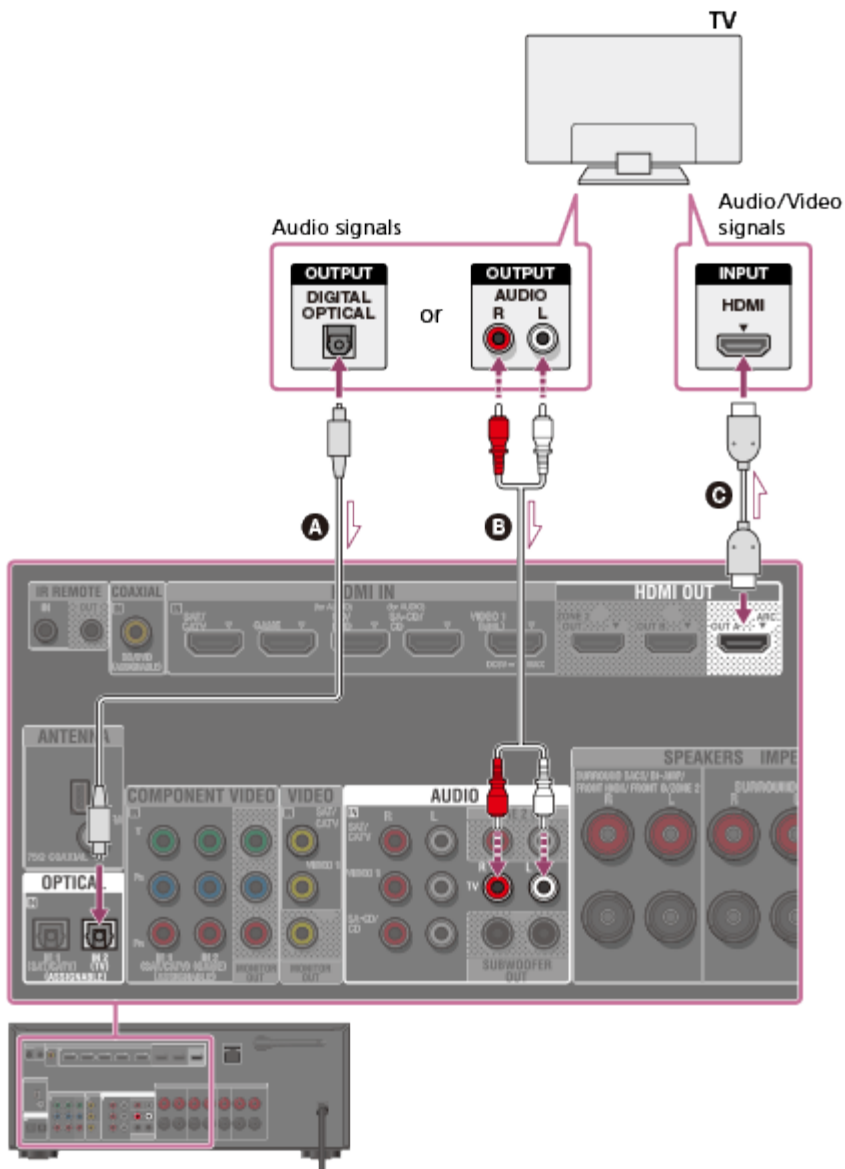

A Optical digital cable (not supplied)

B Audio cable (not supplied)

C HDMI cable (not supplied)

Sony recommends that you use an HDMI-authorized cable or HDMI cable made by Sony.

Connecting a TV without HDMI jacks

The solid lines show recommended connections and the dashed lines show alternative connections.

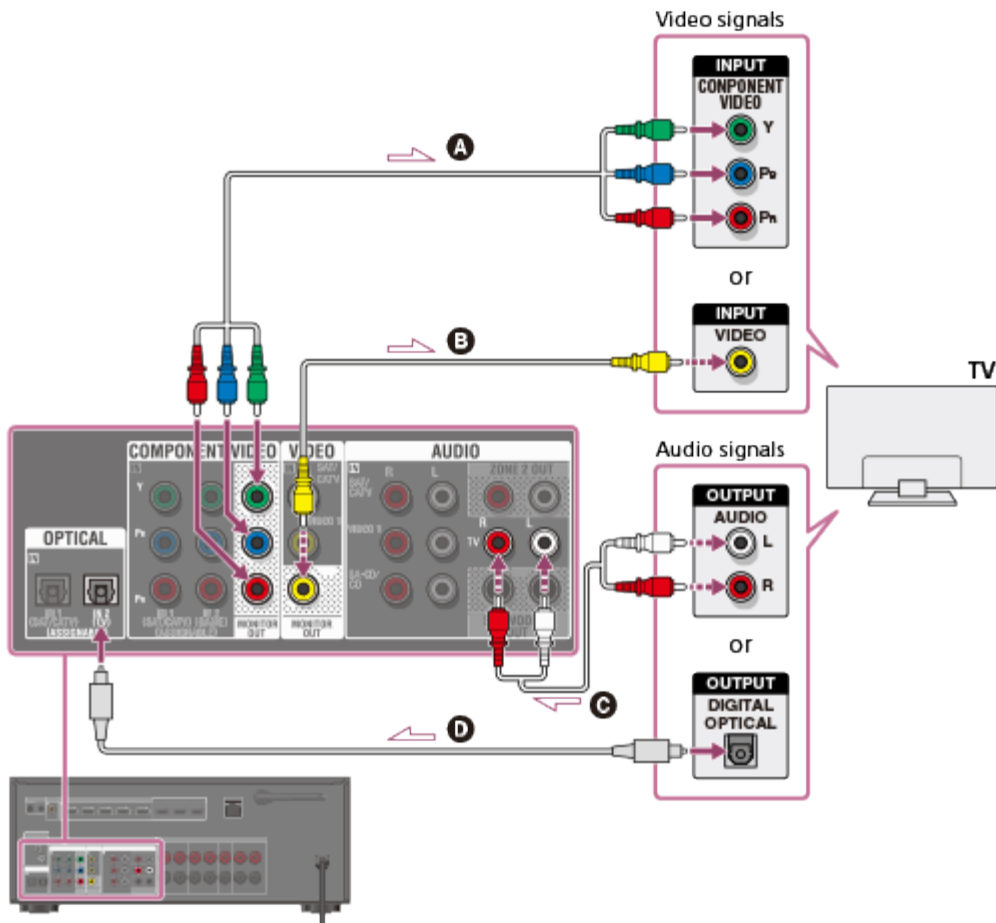

- A** Component video cable (not supplied)
- B** Video cable (not supplied)
- C** Audio cable (not supplied)
- D** Optical digital cable (not supplied)

Note

- Connect a TV monitor or a projector to the HDMI OUT or MONITOR OUT jack on the receiver.
- Depending on the status of the connection between the TV and the antenna (aerial), the image on the TV screen may be distorted. If this is the case, place the antenna (aerial) farther away from the receiver.
- When connecting an optical digital cable, insert the plugs straight until they click into place.
- Do not bend or tie optical digital cables.

Hint

- All of the digital audio jacks are compatible with 32 kHz, 44.1 kHz, 48 kHz, and 96 kHz sampling frequencies.
- The receiver has a video conversion function. For details, see “[Function for conversion of video signals.](#)”
- When connecting a TV to the receiver via the TV IN jacks of the receiver, set the sound output jack of the TV to [Fixed] if it can be switched between either [Fixed] or [Variable].

Related Topic

- [Notes on connecting cables](#)
- [Enjoying sound of TV broadcasts from the receiver](#)

- [Controlling HDMI devices \(Control for HDMI\)](#)
- [Passing HDMI signals through \(Pass Through\)](#)
- [Setting the HDMI audio signal output of connected devices \(Audio Out\)](#)

Notes on use

4-488-938-11(1)

Copyright 2014 Sony Corporation

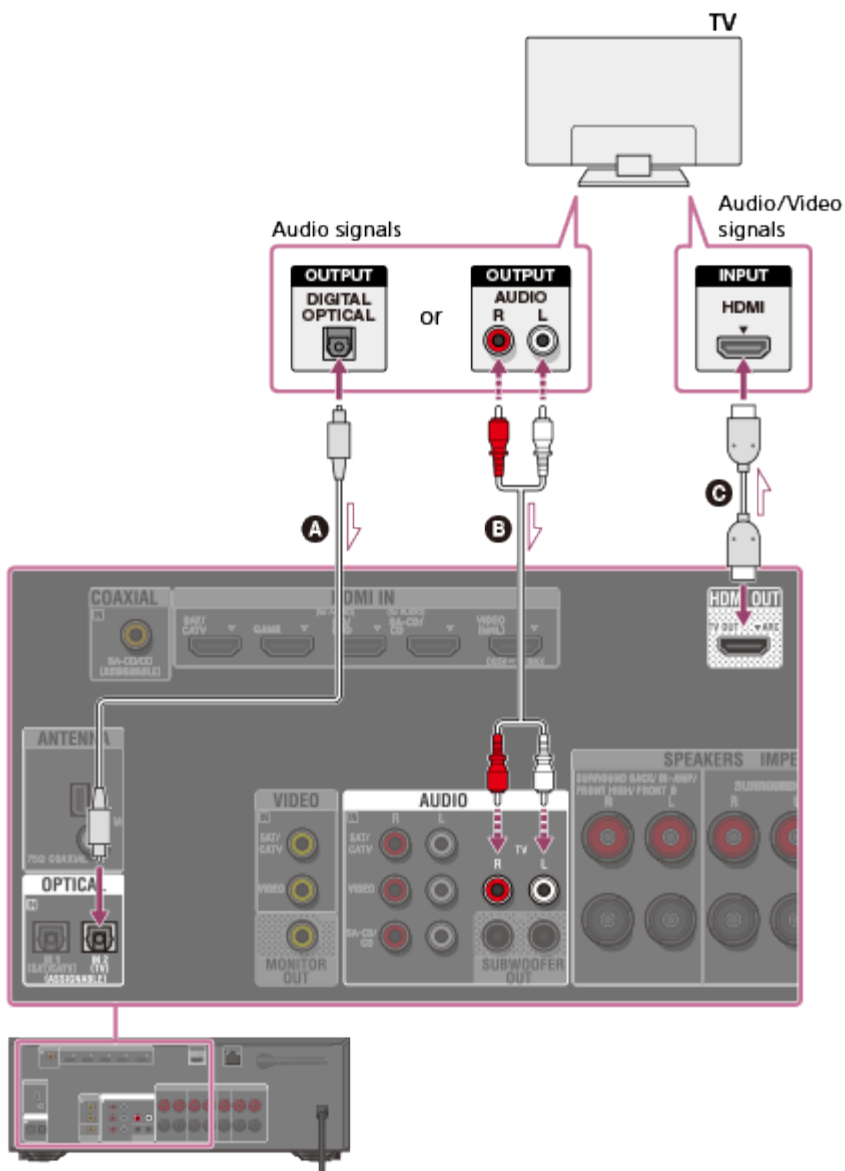

A Optical digital cable (not supplied)

B Audio cable (not supplied)

C HDMI cable (not supplied)

Sony recommends that you use an HDMI-authorized cable or HDMI cable made by Sony.

Connecting a TV without HDMI jacks

The solid lines show recommended connections and the dashed lines show alternative connections.

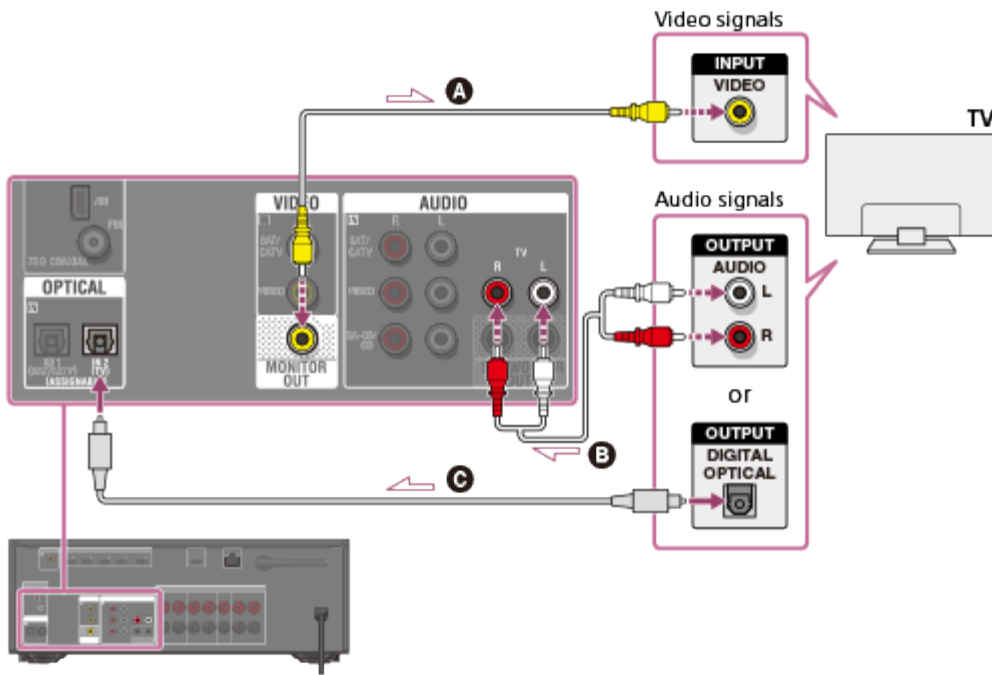

- A** Video cable (not supplied)
- B** Audio cable (not supplied)
- C** Optical digital cable (not supplied)

Note

- Connect a TV monitor or a projector to the HDMI TV OUT or MONITOR OUT jack on the receiver.
- Depending on the status of the connection between the TV and the antenna (aerial), the image on the TV screen may be distorted. If this is the case, place the antenna (aerial) farther away from the receiver.
- When connecting an optical digital cable, insert the plugs straight until they click into place.
- Do not bend or tie optical digital cables.

Hint

- All of the digital audio jacks are compatible with 32 kHz, 44.1 kHz, 48 kHz, and 96 kHz sampling frequencies.
- The receiver has a video conversion function. For details, see “[Function for conversion of video signals.](#)”
- When connecting a TV to the receiver via the TV IN jacks of the receiver, set the sound output jack of the TV to [Fixed] if it can be switched between either [Fixed] or [Variable].

Related Topic

- [Notes on connecting cables](#)
- [Enjoying sound of TV broadcasts from the receiver](#)
- [Controlling HDMI devices \(Control for HDMI\)](#)
- [Passing HDMI signals through \(Pass Through\)](#)
- [Setting the HDMI audio signal output of connected devices \(Audio Out\)](#)

MULTI CHANNEL AV RECEIVER
STR-DN1050/STR-DN850

Connecting devices with HDMI jacks

Connect devices to the receiver as illustrated below.

Before connecting cables, be sure to disconnect the AC power cord (mains lead).

If your device does not have an HDMI jack, see “[Connecting devices with jacks other than HDMI jacks \(for STR-DN1050\)](#)” or “[Connecting devices with jacks other than HDMI jacks \(for STR-DN850\)](#).”

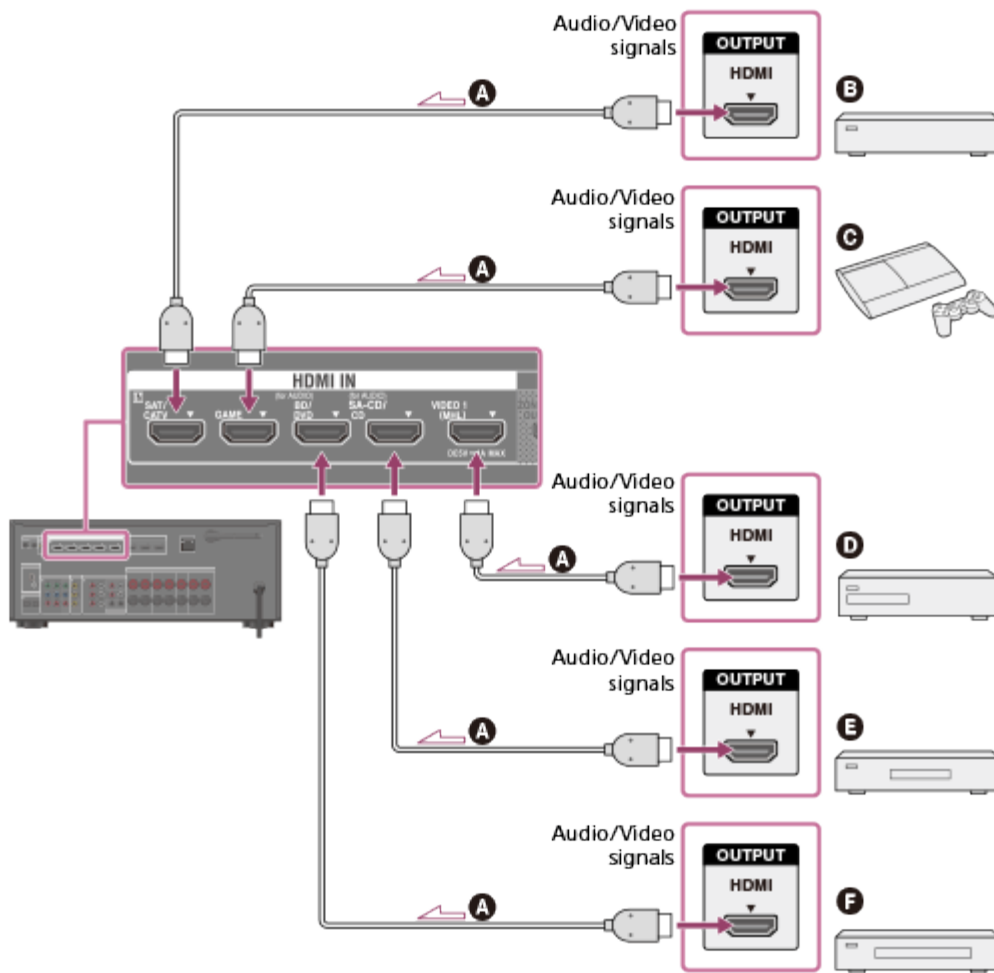

A HDMI cable (not supplied)

Sony recommends that you use an HDMI-authorized cable or Sony HDMI cable.

B Satellite tuner, cable TV tuner

C PlayStation3

D DVD recorder

E Super Audio CD player, CD player

F Blu-ray Disc player, DVD player

Note

- This HDMI connection is an example. You can connect each HDMI device to any HDMI input, including the HDMI input on the front panel.
- The BD/DVD and SA-CD/CD inputs have better sound quality. When you need a higher sound quality, connect your device to these jacks and select them as the input.

Hint

- The image quality depends on the connecting jack. We recommend that you connect your devices via an HDMI connection if they have HDMI jacks.

Related Topic

- [Notes on connecting cables](#)
- [Using HDMI connections](#)
- [Changing the name for each input \(Name\)](#)

[Notes on use](#)

4-488-938-11(1)

Copyright 2014 Sony Corporation

MULTI CHANNEL AV RECEIVER
STR-DN1050/STR-DN850

Connecting devices with jacks other than HDMI jacks (for STR-DN1050)

Connect devices to the receiver as illustrated below.

The solid lines show recommended connections and the dashed lines show alternative connections.

Be sure to disconnect the AC power cord (mains lead) before connecting cables.

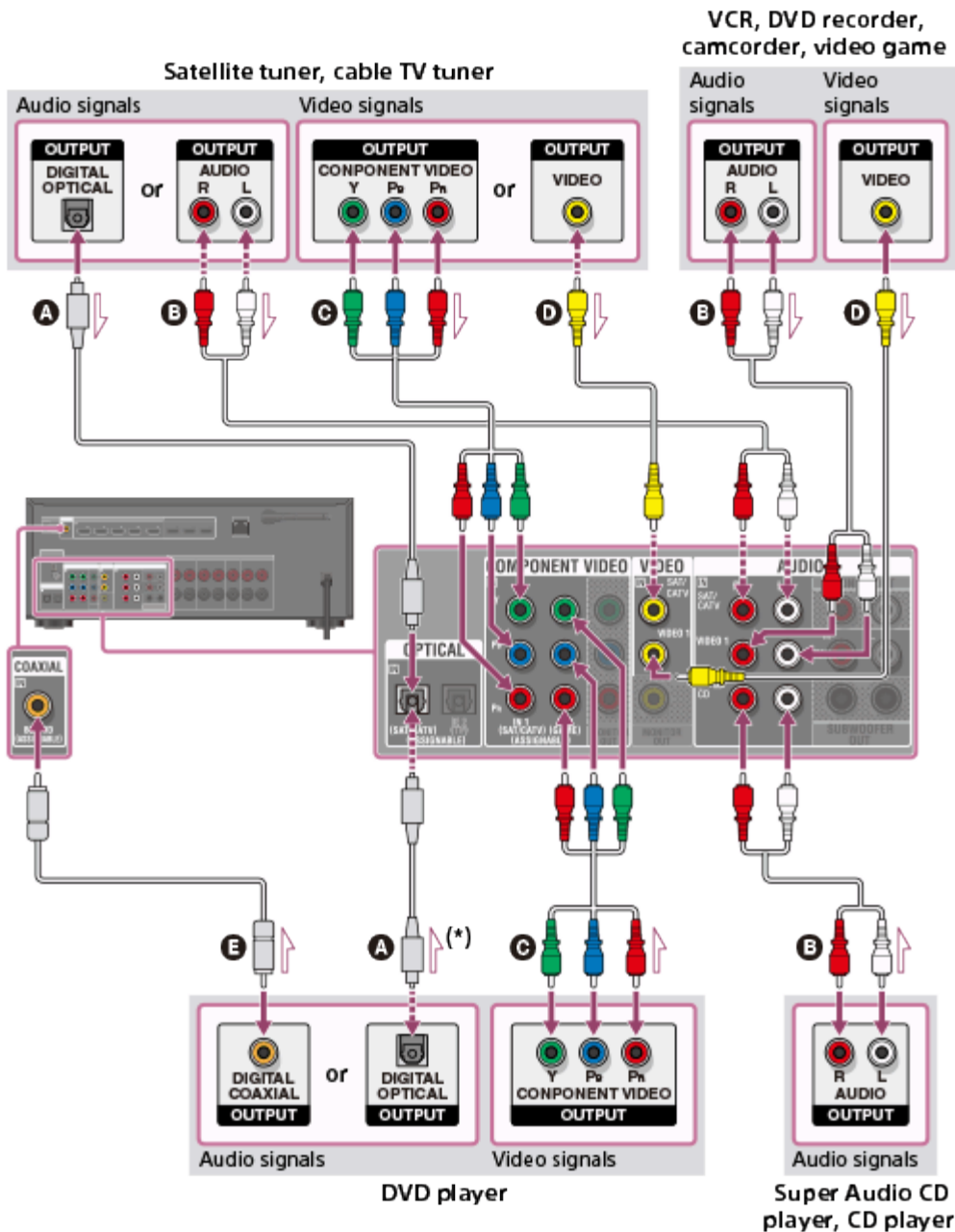

A Optical digital cable (not supplied)

- B Audio cable (not supplied)
- C Component video cable (not supplied)
- D Video cable (not supplied)
- E Coaxial digital cable (not supplied)

* If you connect devices with an OPTICAL jack, reassign the input jacks. For details, see [“Using other video/audio input jacks \(Input Assign\).”](#)

Note

- You can rename each input so that the name can be displayed on the display panel of the receiver. For details, see [“Changing the name for each input \(Name\).”](#)

Hint

- The image quality depends on the connecting jack. We recommend that you connect your devices via an HDMI connection if they have HDMI jacks.

Related Topic

- [Notes on connecting cables](#)
- [Changing the name for each input \(Name\)](#)

Notes on use

4-488-938-11(1)

Copyright 2014 Sony Corporation

MULTI CHANNEL AV RECEIVER
STR-DN1050/STR-DN850

Connecting devices with jacks other than HDMI jacks (for STR-DN850)

Connect devices to the receiver as illustrated below.

The solid lines show recommended connections and the dashed lines show alternative connections.

Be sure to disconnect the AC power cord (mains lead) before connecting cables.

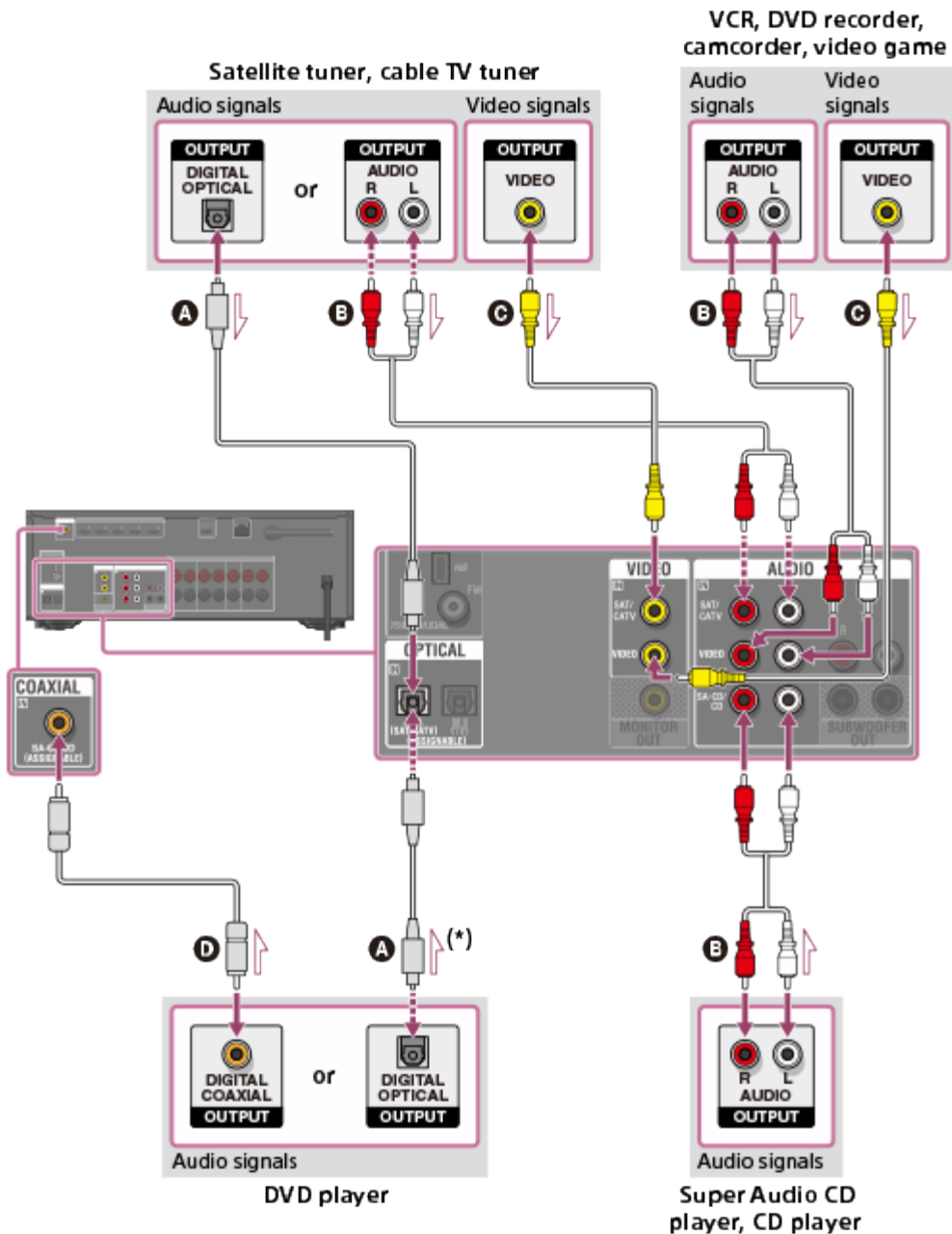

A Optical digital cable (not supplied)

- Ⓑ Audio cable (not supplied)
- Ⓒ Video cable (not supplied)
- Ⓓ Coaxial digital cable (not supplied)

* If you connect devices with an OPTICAL jack, reassign the input jacks. For details, see “[Using other video/audio input jacks \(Input Assign\)](#).”

Note

- You can rename each input so that the name can be displayed on the display panel of the receiver. For details, see “[Changing the name for each input \(Name\)](#).”

Hint

- The image quality depends on the connecting jack. We recommend that you connect your devices via an HDMI connection if they have HDMI jacks.

Related Topic

- [Notes on connecting cables](#)
- [Changing the name for each input \(Name\)](#)

[Notes on use](#)

4-488-938-11(1)

Copyright 2014 Sony Corporation

MULTI CHANNEL AV RECEIVER
STR-DN1050/STR-DN850

Connecting an iPhone, iPod, or USB device

Connect an iPhone, iPod or USB device as illustrated below.

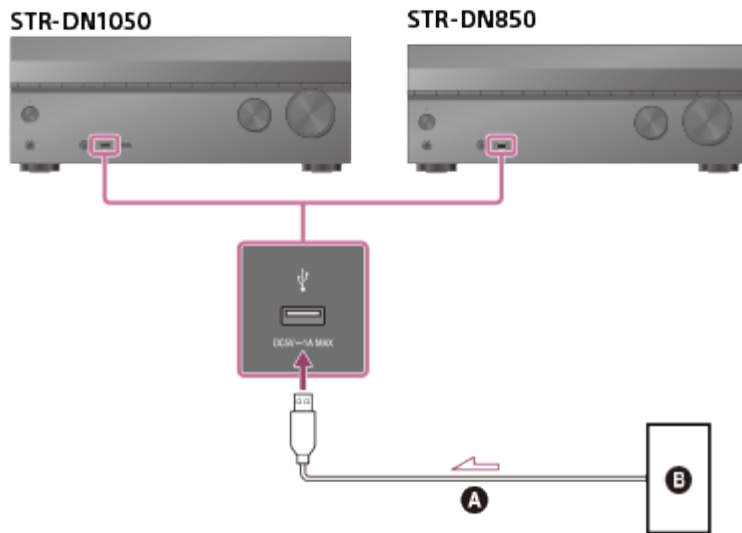

- A** USB cable (not supplied)
- B** iPhone, iPod, or USB device

[Notes on use](#)

4-488-938-11(1)

Copyright 2014 Sony Corporation

MULTI CHANNEL AV RECEIVER
STR-DN1050/STR-DN850

Connecting an MHL-compatible mobile device

Connect an MHL-compatible mobile device as illustrated below.
This receiver supports MHL 2 technology.

Front (for STR-DN1050 only)

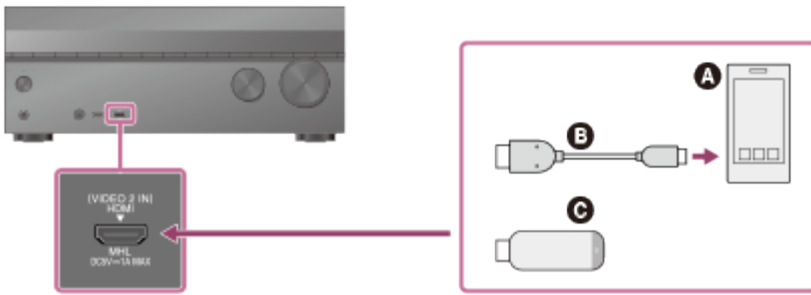

Rear

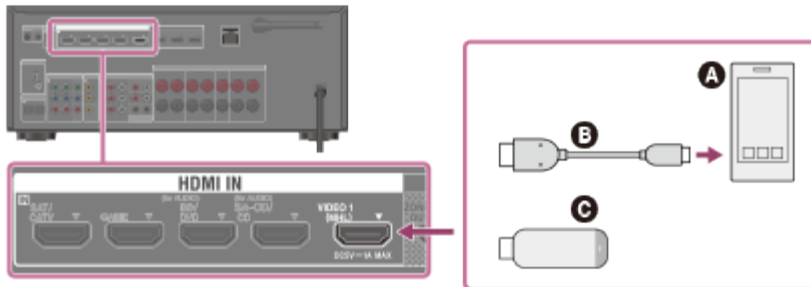

- A** Mobile device
- B** MHL cable (not supplied)
Use an MHL 2-compliant cable.
Sony recommends that you use an MHL cable made by Sony.
- C** MHL Direct Attach Device

Related Topic

[Using MHL \(Mobile High-Definition Link\) connections](#)

MULTI CHANNEL AV RECEIVER
STR-DN1050/STR-DN850

Connecting the antennas (aerials)

Connect the supplied antennas (aerials) to the receiver as illustrated below.
Be sure to disconnect the AC power cord (mains lead) before connecting the antennas (aerials).

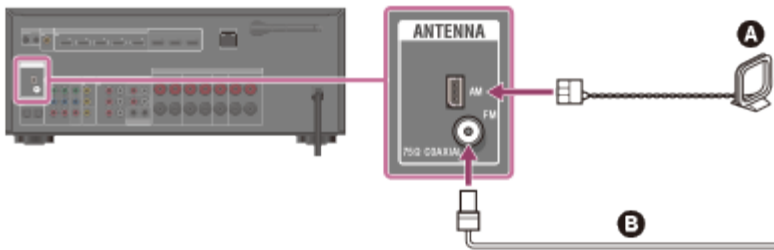

- A** AM loop antenna (aerial) (supplied)
- B** FM wire antenna (aerial) (supplied)

Note

- To prevent noise pickup, keep the AM loop antenna (aerial) away from the receiver and other devices.
- Be sure to fully extend the FM wire antenna (aerial).
- After connecting the FM wire antenna (aerial), keep it as horizontal as possible.

Related Topic

- [Notes on connecting cables](#)

[Notes on use](#)

4-488-938-11(1)

Copyright 2014 Sony Corporation

MULTI CHANNEL AV RECEIVER
STR-DN1050/STR-DN850

Connecting another amplifier in zone 2 (for STR-DN1050 only)

You can enjoy image (*) and sound from a device connected to the receiver in a zone other than the main zone. For example, you can watch a DVD in the main zone and listen to a CD in zone 2.

* For a connection using the HDMI ZONE 2 OUT jack only

Connecting another amplifier using the AUDIO ZONE 2 OUT jack

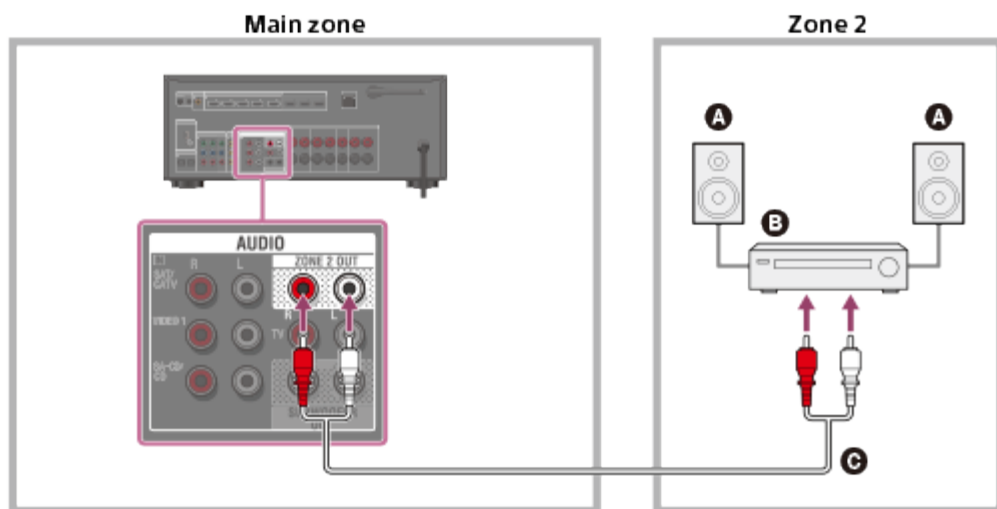

- Ⓐ Speakers
- Ⓑ Amplifier/receiver made by Sony
- Ⓒ Audio cable (not supplied)

Note

- Only analog audio signals are output in zone 2.

Connecting another amplifier using the HDMI ZONE 2 OUT jack

HDMI input video/audio signals are output in zone 2 using the HDMI ZONE 2 OUT jack of the receiver.

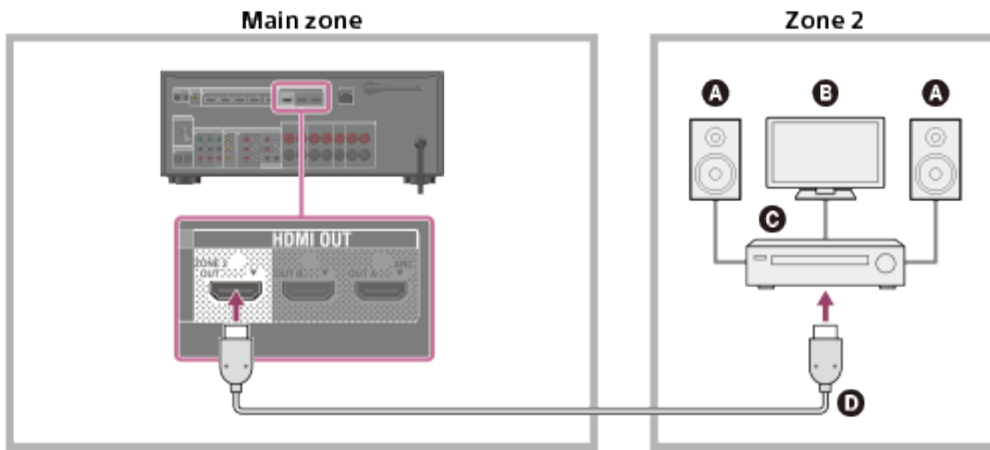

- **A** Speakers
- **B** TV
- **C** Amplifier/receiver made by Sony
- **D** HDMI cable (not supplied)

Note

- To use this connection, set [Zone2 Out] in the HDMI Settings menu to [On].

Related Topic

- [Notes on connecting cables](#)

[Notes on use](#)

4-488-938-11(1)

Copyright 2014 Sony Corporation

MULTI CHANNEL AV RECEIVER
STR-DN1050/STR-DN850

Connecting the receiver to the network using a LAN cable (for wired LAN connections only)

The following illustration is an example configuration of a home network with the receiver and a server. We recommend that you connect the server to the router with a wired connection.

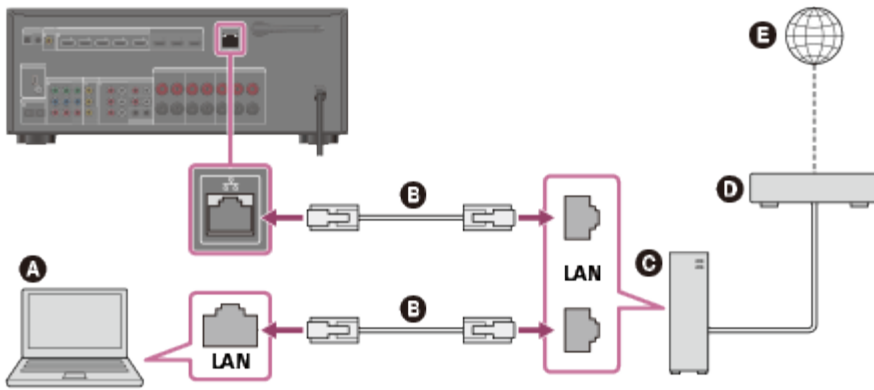

- A** Server
- B** LAN cable (not supplied)
- C** Router
- D** Modem
- E** Internet

Related Topic

- [Notes on connecting cables](#)
- [System requirements for a wired LAN connection](#)
- [Setting up a wired LAN connection](#)

Notes on use

4-488-938-11(1)

Copyright 2014 Sony Corporation

MULTI CHANNEL AV RECEIVER
STR-DN1050/STR-DN850

Connecting the receiver to the network using the wireless LAN antenna (for wireless LAN connections only)

The following illustration is an example configuration of a home network with the receiver and a server. We recommend that you connect the server to the router with a wired connection.

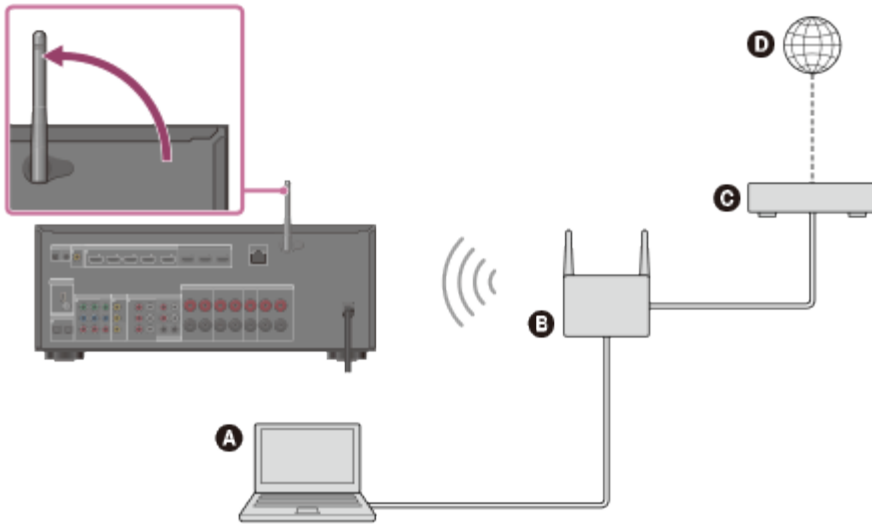

- A** Server
- B** Router
- C** Modem
- D** Internet

Note

- Audio playback on a server may occasionally be interrupted if you use a wireless connection.

Related Topic

- [System requirements for a wireless LAN connection](#)
- [Selecting a wireless LAN connection method](#)

Notes on use

4-488-938-11(1)

Copyright 2014 Sony Corporation



MULTI CHANNEL AV RECEIVER
STR-DN1050/STR-DN850

Setting the voltage selector

If your receiver has a voltage selector on the rear panel, check that the voltage selector is set to the local power supply voltage. If not, use a screwdriver to set the selector to the correct position before connecting the AC power cord (mains lead) to a wall outlet.

The voltage selector may differ depending on the area.

[Notes on use](#)

4-488-938-11(1)

Copyright 2014 Sony Corporation

MULTI CHANNEL AV RECEIVER
STR-DN1050/STR-DN850

Inserting batteries into the remote control

Insert two R03 (size AAA) batteries (supplied) into the remote control. Make sure that the + and - ends are in the correct position when installing batteries.

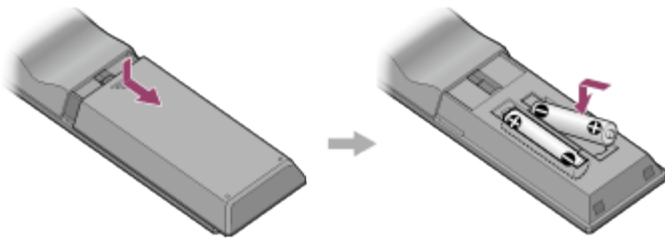

Note

- Do not leave the remote control in an extremely hot or humid place.
- Do not use a new battery with an old one.
- Do not mix manganese batteries with other kinds of batteries.
- Do not expose the remote control sensor to direct sunlight or lights. Doing so may cause a malfunction.
- If you do not intend to use the remote control for an extended period of time, remove the batteries to avoid possible damage from battery leakage and corrosion.
- When the receiver no longer responds to the remote control, replace both of the batteries with new ones.

Notes on use

4-488-938-11(1)

Copyright 2014 Sony Corporation

MULTI CHANNEL AV RECEIVER
STR-DN1050/STR-DN850

Turning on the receiver

When you have made all connections with the other devices, connect the AC power cord (mains lead), then turn on the receiver.

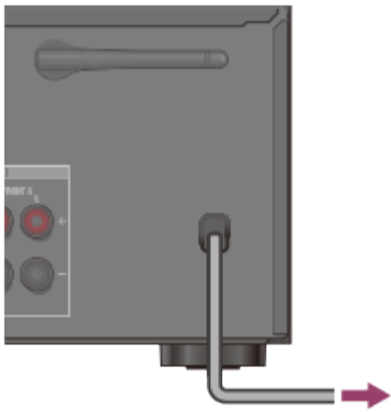

1. Connect the AC power cord (mains lead) to a wall outlet.



2. Press  (on/standby) to turn on the receiver.





You can also turn on the receiver using  (on/standby) on the remote control. To turn off the receiver, press  (on/standby) again.

Note

- After you turn off the receiver, [STANDBY] flashes on the display panel. Do not disconnect the AC power cord (mains lead) while [STANDBY] is flashing. This may cause a malfunction.



MULTI CHANNEL AV RECEIVER
STR-DN1050/STR-DN850

Setting up the receiver using the Easy Setup

When you turn on the receiver for the first time or after the receiver is initialized, the Easy Setup screen appears on the TV screen. You can set up the following settings for the receiver by following the instructions on the Easy Setup screen.

- **Speaker Settings**
Perform automatic calibration in accordance with your speaker system configuration and arrangement.
- **Network Settings**
Configure settings to connect the receiver to the network.

Note

- Switch the input of the TV to the input to which the receiver is connected to use this function.

If the Easy Setup screen does not appear or you want to display the Easy Setup screen manually, you can display it by selecting [Settings] - [Easy Setup] from the home menu.

Related Topic

- [Adjusting the sound balance automatically \(Auto Calibration\)](#)
- [Setting up a wired LAN connection](#)
- [Selecting a wireless LAN connection method](#)

Notes on use

4-488-938-11(1)

Copyright 2014 Sony Corporation

MULTI CHANNEL AV RECEIVER
STR-DN1050/STR-DN850

Using the menu on the TV screen

You can display the menu of the receiver on the TV screen.

1. Switch the input of the TV to the input to which the receiver is connected.
2. Press HOME to display the home menu on the TV screen.

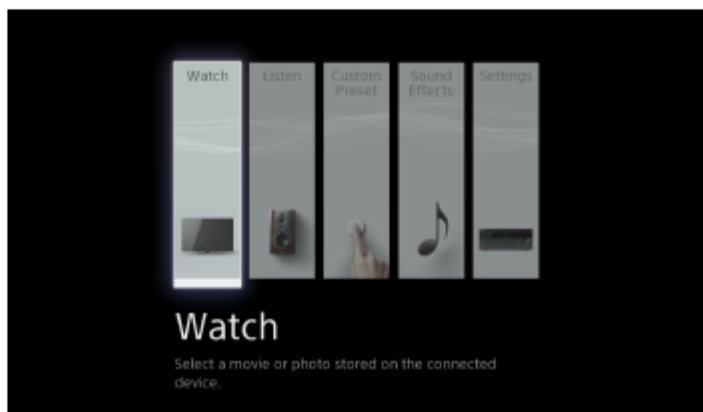

3. Press **↑/↓/←/→** repeatedly to select the menu you want, then press **+** to enter the menu.

Home menu items

Watch: Select to display video from the connected device.

Listen: Select to listen to sound from the connected device.

Custom Preset: Select to save various settings for the receiver and recall those settings.

Sound Effects: Select to enjoy sound effects.

Settings: Select to adjust the various settings for the receiver.

Hint

- When [OPTIONS] appears in the lower right portion of the TV screen, you can display the function list by pressing OPTIONS and selecting a related function.
- To return to the previous screen, press RETURN.
- To exit the menu, press HOME to display the home menu, then press HOME again.

Notes on use

4-488-938-11(1)

Copyright 2014 Sony Corporation

MULTI CHANNEL AV RECEIVER
STR-DN1050/STR-DN850

Enjoying video/sound from the connected device

1. Switch the input of the TV to the input to which the receiver is connected.
2. Press HOME.
The home menu is displayed on the TV screen.
Depending on the TV, the home menu may take some time to appear on the TV screen.

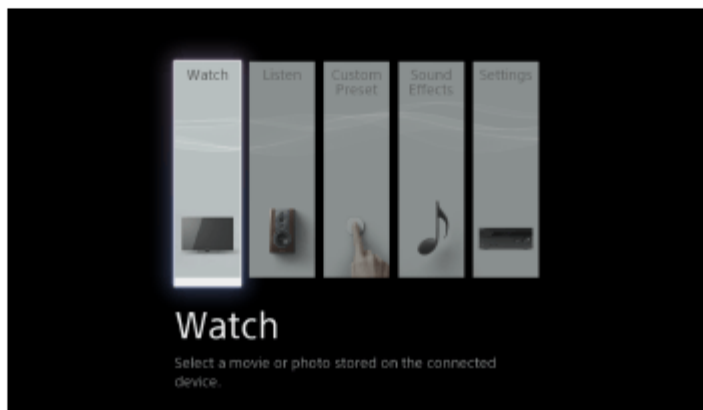

3. Select [Watch] or [Listen] from the home menu.
The menu item list appears on the TV screen.
4. Select the device you want.
5. Turn on the device and start playback.
6. Press \triangle +/- to adjust the volume.
You can also use MASTER VOLUME on the receiver.
7. Press A.F.D./2CH, MOVIE or MUSIC to enjoy the surround sound.
You can also use A.F.D./2CH, MOVIE or MUSIC on the receiver. For details, see [“Selecting a sound field \(Sound Field\).”](#)

Note

- Before you turn off the receiver, be sure to turn down the volume level to avoid damaging your speakers.

Hint

- You can turn INPUT SELECTOR on the receiver or press the input buttons on the remote control to select the device you want.

You can adjust the volume differently using the MASTER VOLUME knob on the receiver or the +/- buttons on the remote control.

To turn the volume up or down quickly

- Turn the knob quickly.
- Press and hold one of the buttons.

To make fine adjustments

- Turn the knob slowly.
- Press one of the buttons and release it immediately.

Notes on use

4-488-938-11(1)

Copyright 2014 Sony Corporation



MULTI CHANNEL AV RECEIVER
STR-DN1050/STR-DN850

Compatible iPhone/iPod/iPad models

You can use the following iPhone/iPod models on this receiver. Update your iPhone/iPod/iPad with the latest software before using it.

When connected via USB

- iPhone:
iPhone 5s/iPhone 5c/iPhone 5/iPhone 4s/iPhone 4/iPhone 3GS/iPhone 3G
- iPod touch:
iPod touch (2nd through 5th generation)
- iPod:
iPod classic
- iPod nano:
iPod nano (3rd through 7th generation)

When connected via BLUETOOTH

- iPhone:
iPhone 5s/iPhone 5c/iPhone 5/iPhone 4s/iPhone 4/iPhone 3GS
- iPod touch:
iPod touch (4th and 5th generation)

When using AirPlay

- iPhone:
iPhone 5s/iPhone 5c/iPhone 5/iPhone 4s/iPhone 4/iPhone 3GS
- iPad:
iPad (4th generation)/iPad mini/iPad (3rd generation)/iPad 2
- iPod touch:
iPod touch (3rd thorough 5th generation)

[Notes on use](#)

4-488-938-11(1)

Copyright 2014 Sony Corporation



MULTI CHANNEL AV RECEIVER
STR-DN1050/STR-DN850

Notes on iPhone/iPod

- Sony cannot accept responsibility in the event that data recorded to an iPhone/iPod is lost or damaged when using an iPhone/iPod connected to this receiver.
- iPhone/iPod is charged when connected to the receiver while the receiver is turned on.
- You cannot transfer songs onto the iPhone/iPod from the receiver.
- Do not remove the iPhone/iPod during operation. To avoid data corruption and damage to the iPhone/iPod, turn the receiver off when connecting or removing the iPhone/iPod.

Related Topic

[iPhone/iPod message list](#)

Notes on use

4-488-938-11(1)

Copyright 2014 Sony Corporation

MULTI CHANNEL AV RECEIVER
STR-DN1050/STR-DN850



Enjoying audio content stored on an iPhone/iPod via the USB port

You can enjoy music from an iPhone or iPod by connecting it to the  (USB) port on the receiver.

1. Select [Listen] - [USB] from the home menu.
When an iPhone or iPod is connected, [iPod/iPhone] appears on the TV screen.
2. Follow the on-screen instructions to select the iPhone/iPod control mode.

Operating an iPhone/iPod using the remote control

Press USB before you use the following buttons:

- : Starts or pauses playback.
- : Moves to the start of the previous/current or next track.

Note

- When connecting the receiver to the network via a wired LAN connection, the USB function temporarily may not work due to the power status of the router or the network connection status, etc. Please wait as the function will recover after a short period of time.

Related Topic

- [Connecting an iPhone, iPod, or USB device](#)

[Notes on use](#)

4-488-938-11(1)

Copyright 2014 Sony Corporation

MULTI CHANNEL AV RECEIVER
STR-DN1050/STR-DN850

Enjoying audio content from iTunes or an iPhone/iPad/iPod via the network (AirPlay)

You can play audio content on an iPhone, iPad, iPod touch or in an iTunes Library on your PC with this receiver via a wireless network.

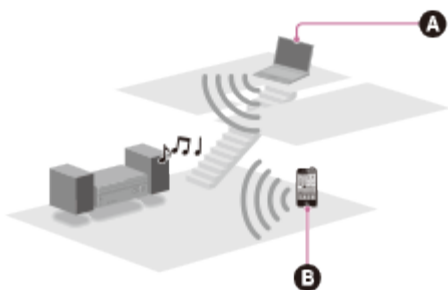

- A PC
- B iPhone/iPad/iPod touch

1. Tap/click icon on the iPhone/iPad/iPod screen or iTunes window.
2. Select [STR-DN1050] or [STR-DN850] on the AirPlay menu of iTunes or your iPhone/iPad/iPod.
3. Start playing back audio content on an iPhone/iPad/iPod or in iTunes.

Controlling AirPlay playback

You can use the buttons on the remote control when the receiver is selected as the device for output.

Note

- Update the iPhone/iPad/iPod or iTunes to the latest version before using with the receiver.
- Refer to the operating instructions of your device for details on operating the iPhone/iPad/iPod, iTunes or AirPlay.

Hint

- If the playback does not start, perform the process again from step 1.
- The device name displayed on the AirPlay menu may be different. To confirm or edit the device name, see [“Assigning a name to the receiver \(Device Name\).”](#)
- Very loud sound may output from the receiver if you set the volume loud on an iPhone/iPad/iPod or iTunes.
- It may not be possible to link the volume level of an iPhone/iPad/iPod or iTunes with the volume level of this receiver.

Related Topic

- [Assigning a name to the receiver \(Device Name\)](#)

Notes on use

4-488-938-11(1)

Copyright 2014 Sony Corporation



MULTI CHANNEL AV RECEIVER
STR-DN1050/STR-DN850

Enjoying audio content stored on a BLUETOOTH device

1. Place the BLUETOOTH device within 1 meter (3.3 feet) of the receiver.
2. Press BLUETOOTH on the receiver to select the BLUETOOTH function.
3. Hold down BLUETOOTH for 2 seconds to activate the pairing mode of the receiver.
[PAIRING] appears and [BT] flashes quickly on the display panel. Perform step 4 within five minutes, otherwise pairing will be canceled. In this case, repeat this step.
4. Perform pairing on the BLUETOOTH device to detect this receiver.
For details, refer to the operating instructions of your BLUETOOTH device.
A list of detected devices may appear on the BLUETOOTH device display depending on the type of BLUETOOTH device. This receiver is displayed as [STR-DN1050] or [STR-DN850] .
5. Select [STR-DN1050] or [STR-DN850] on the BLUETOOTH device display.
If [STR-DN1050] or [STR-DN850] is not displayed, repeat this process from step 1.
6. Check that the connection is completed and [BT] lights up on the display panel.
7. Start playback on the BLUETOOTH device.
8. Adjust the volume.
Adjust the volume of the BLUETOOTH device first. If the volume level is still too low, adjust the volume level of the receiver.

Canceling pairing operation

Hold down BLUETOOTH after step 3. [CANCEL] appears on the display panel.

Note

- When establishing a connection with this receiver in step 4, select the audio profile (A2DP or AVRCP) on the BLUETOOTH device. If the BLUETOOTH device does not support the AVRCP profile, you cannot perform playback or other operations on the receiver.
- If a passkey is required on the display of the BLUETOOTH device in step 5, enter [0000]. The passkey may be called "Passcode," "PIN code," "PIN number" or "Password."
- You can pair up to 9 BLUETOOTH devices. If a 10th BLUETOOTH device is paired, the least recently connected device will be replaced by the new one.

Hint

- On some types of BLUETOOTH devices, you can adjust the volume using the controls of the BLUETOOTH device.

- You can also activate the pairing mode of the receiver by the following ways:
 - Press OPTIONS while the input is set to [Bluetooth], then select [Pairing].
 - Select [Bluetooth Pairing] in the Bluetooth Settings menu.

Related Topic

- [Controlling a BLUETOOTH device using the remote control](#)
- [Checking the information of a connected BLUETOOTH device](#)
- [Setting the Bluetooth Standby mode \(Bluetooth Standby\)](#)
- [Setting BLUETOOTH audio codecs \(Bluetooth AAC/Bluetooth aptX\)](#)

[Notes on use](#)

4-488-938-11(1)

Copyright 2014 Sony Corporation



MULTI CHANNEL AV RECEIVER
STR-DN1050/STR-DN850

Compatible USB devices and USB specifications

Verified Sony USB devices

You can use the following Sony USB devices on this receiver:

Walkman:

NW-A857/A860

NW-E053/E060/E083

NW-F800

NW-M505

NW-S756/S760/S770/S785

NW-WH303

NW-Z1000/Z1070

NWD-W260/W273

NWZ-A864

NWZ-B162F/B172/B183

NWZ-E053/E363/E373/E385/E463/E575/E585

NWZ-F805/F885

NWZ-S755/S764/S774

NWZ-W262/W272

NWZ-WH303/WH505

NWZ-Z1040/Z1070

MICROVAULT:

USM1GL/4GL/8GL/32GL

USM16GLX/32GLX/64GLX

USM512J/8GJ

USM4GM/16GM

USM4GN/8GN/16(32)GN

USM64GP

USM8GQ/32GQ/64GQ

USM8GR/16GR/32GR

USM4GS/16GS

USM8GT

USM16GU

Digital Voice Recorder:

ICD-AX412F

ICD-FX8

ICD-PX232/PX312F/PX333F

ICD-SX813/SX1000

ICD-UX502/UX513F/UX523F/UX532/UX543

ICD-TX50

ICZ-R50/R51

PCM-D100

- The receiver is unable to read data in NTFS format.
- The receiver is unable to read data other than that saved in the first partition of a hard disk drive.
- Operation of models not listed here is not guaranteed.
- Operation may not always be guaranteed even when using these USB devices.
- Some of these USB devices may not be available for purchase in certain areas.
- When formatting the above models, be sure to format using the model itself or the dedicated formatting software for that model.
- When connecting a USB device to the receiver, be sure to connect after the display Creating Library or Creating Database on the USB device has disappeared.

USB specifications

Supported formats (*1)

The music file formats that can be played back by this receiver are as follows:

MP3 (MPEG 1 Audio Layer-3):

32 kbps – 320 kbps, VBR

AAC (*2):

16 kbps – 320 kbps, CBR, VBR

WMA9 Standard (*2):

40 kbps – 320 kbps, CBR, VBR

WAV:

32 kHz – 192 kHz, 16/24 bit PCM

FLAC:

44.1 kHz – 192 kHz, 16/24 bit FLAC

AIFF:

32 kHz – 192 kHz, 16/24 bit PCM

ALAC:

32 kHz - 96 kHz, 16/24 bit ALAC

DSD (for STR-DN1050 only):

2.8 MHz, 1 bit DSD

*1 Compatibility with all encoding/writing software, recording devices and recording media cannot be guaranteed.

*2 The receiver does not play files encoded with DRM.

Compatible USB device

Mass Storage Class, High-speed type

Maximum current

500 mA

[Notes on use](#)

4-488-938-11(1)

Copyright 2014 Sony Corporation

MULTI CHANNEL AV RECEIVER
STR-DN1050/STR-DN850

Notes on USB devices

- Do not remove a USB device during operation. To avoid data corruption and damage to the USB device, turn the receiver off when connecting or removing a USB device.
- Do not connect a USB device to the receiver through a USB hub.
- When a USB device is connected, [Reading] appears.
- It may take about 10 seconds before [Reading] appears depending on the type of USB device connected.
- When a USB device is connected, the receiver reads all of the files on the USB device. If there are many folders or files on the USB device, it may take a long time to finish reading the USB device.
- The receiver can recognize up to
 - 256 folders (including [ROOT] folder).
 - 256 audio files in each folder.
 - 8 folder levels (tree structure of files, including [ROOT] folder).

The maximum number of audio files and folders may vary depending on the file and folder structure. Do not save other types of files or unnecessary folders on a USB device.

- Compatibility with all encoding/writing softwares, recording devices, and recording media cannot be guaranteed. Incompatible USB devices may produce noise or interrupted audio or may not play at all.
- Some time may be needed to start playback when:
 - the folder structure is complex.
 - the memory capacity is excessive.
- This receiver does not necessarily support all of the functions provided in a connected USB device.
- The playback order for the receiver may differ from the playback order of the connected USB device.
- If folders that have no audio files are selected, [No Track] appears.
- When playing a very long track, some operations may cause playback delay.

Related Topic

[USB message list](#)

Notes on use

4-488-938-11(1)

Copyright 2014 Sony Corporation

MULTI CHANNEL AV RECEIVER
STR-DN1050/STR-DN850

Enjoying audio content stored on a USB device

You can enjoy music from a USB device by connecting it to the ψ (USB) port on the receiver.

1. Select [Listen] - [USB] from the home menu.

When the USB device is connected, [USB] appears on the TV screen. You can operate the USB device using the remote control of the receiver.

2. Select the content you want from the content list.

The selected content starts playing and the information of music content appears on the TV screen.

Operating the USB device using the remote control

Press USB before you use the following buttons:

- : Starts or pauses playback.
- : Stops playback.
- : Moves to the start of the previous/current or next track.

Note

- When connecting the receiver to the network via a wired LAN connection, the USB function temporarily may not work due to the power status of the router or the network connection status, etc. Please wait as the function will recover after a short period of time.

Related Topic

- [Connecting an iPhone, iPod, or USB device](#)

Notes on use

4-488-938-11(1)

Copyright 2014 Sony Corporation

MULTI CHANNEL AV RECEIVER
STR-DN1050/STR-DN850

Listening to FM/AM radio

You can listen to FM and AM broadcasts through the built-in tuner. Before operation, be sure you have connected the FM and AM antennas (aerials) to the receiver.

1. Select [Listen] - [FM TUNER] or [AM TUNER] from the home menu.
The FM/AM screen appears.

FM/AM screen

You can select and operate each item on the screen by pressing \uparrow / \downarrow / \leftarrow / \rightarrow and \oplus .

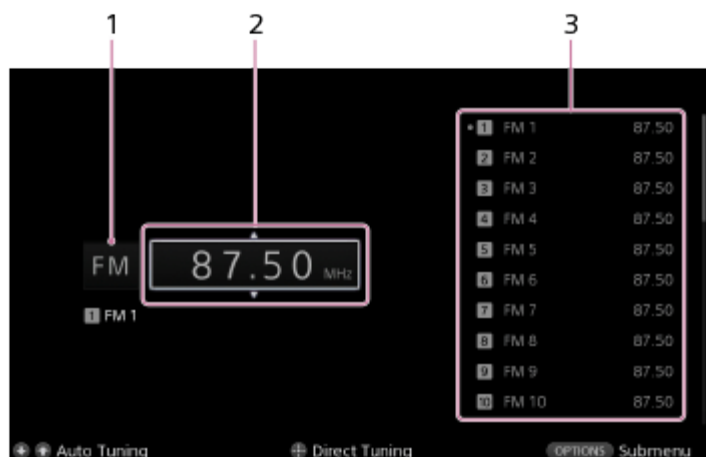

1. Band indication
You can select [FM] or [AM] by pressing \uparrow / \downarrow repeatedly.
2. Frequency indication
You can tune to a station automatically by pressing \uparrow / \downarrow repeatedly (Auto Tuning).
Press \uparrow to scan from lower to higher frequency stations or press \downarrow to scan from higher to lower stations.
The receiver stops scanning whenever a station is received.
3. Preset station list
You can tune to a station by selecting the preset number from the list.

Related Topic

- [Connecting the antennas \(aerials\)](#)



MULTI CHANNEL AV RECEIVER
STR-DN1050/STR-DN850

Presetting FM/AM radio stations (Preset Memory)

You can store up to 30 FM and 30 AM stations as your favorite stations.

1. Select [Listen] - [FM TUNER] or [AM TUNER] from the home menu.
2. Tune to the station that you want to preset.
3. Press OPTIONS.
4. Select [Preset Memory] from the options menu.
5. Select a preset number.
The station is stored as the selected preset number.
6. Repeat steps 1 to 5 to store another station.
You can store stations as follows:
 - AM band: AM 1 to AM 30
 - FM band: FM 1 to FM 30

Related Topic

[Naming preset stations \(Name Input\)](#)

Notes on use

4-488-938-11(1)

Copyright 2014 Sony Corporation

MULTI CHANNEL AV RECEIVER
STR-DN1050/STR-DN850

Tuning to a station directly (Direct Tuning)

You can enter the frequency of a station directly.

1. Select [Listen] - [FM TUNER] or [AM TUNER] from the home menu.
2. Press **+**.
3. Enter the frequency using **↑/↓/←/→**.
 - i. Press **←/→** to select a digit.
 - ii. Press **↑/↓** to change the digit.
4. Press **+**.

Note

- If the tuned frequency is invalid or out of range, [---.-- MHz] or [---- kHz] appears and then the screen returns to the current frequency.
Make sure you have entered the right frequency. If not, repeat steps 3 and 4. If you still cannot tune to a station, the frequency may not be in use in your area.

Hint

- Adjust the direction of the AM loop antenna (aerial) for optimum reception upon tuning to an AM station.
- The tuning scale for direct tuning is shown below:
 - USA and Canada
FM: 100 kHz
AM: 10 kHz (*)
 - Mexico
FM: 50 kHz
AM: 10 kHz (*)
 - Europe and Australia
FM: 50 kHz
AM: 9 kHz

* The AM tuning scale can be changed. For details, see “ [Changing the AM tuning scale \(for USA, Canadian, and Mexican models only\)](#).”



MULTI CHANNEL AV RECEIVER
STR-DN1050/STR-DN850

Changing the AM tuning scale (for USA, Canadian, and Mexican models only)

You can change the AM tuning scale to either 9 kHz or 10 kHz using the buttons on the receiver. Be sure to use the buttons on the receiver to perform this operation.

1. Turn off the receiver.
2. Hold down SPEAKERS and press I/ON (on/standby) on the receiver.
The current AM tuning scale is changed to 9 kHz (or 10 kHz). To reset the scale to 10 kHz (or 9 kHz), repeat the procedure above.

Note

- Depending on the settings, the receiver may take some time to change the AM tuning scale.
- All preset stations will be erased when you change the tuning scale.

Notes on use

4-488-938-11(1)

Copyright 2014 Sony Corporation



MULTI CHANNEL AV RECEIVER
STR-DN1050/STR-DN850

Receiving RDS broadcasts (for European and Australian models only)

This receiver allows you to use Radio Data System (RDS), which enables FM radio stations (*) to send additional information along with the regular programming signal. This receiver offers convenient RDS features, such as Program Service name display.

* Not all FM stations provide RDS service, nor do they provide the same type of services. If you are not familiar with the RDS services in your area, check with your local radio stations for details.

1. Select [Listen] - [FM TUNER] from the home menu.

2. Select a station.

When you tune to a station that provides RDS services, the Program Service name appears on the TV screen and the display panel.

Note

- RDS may not work properly if the station you tuned to does not transmit the RDS signal or if the signal strength is weak.
- Some letters that can be displayed on the TV screen cannot be displayed on the display panel.

Hint

- You can check the frequency while a Program Service name is displayed by pressing DISPLAY repeatedly.

Notes on use

4-488-938-11(1)

Copyright 2014 Sony Corporation

MULTI CHANNEL AV RECEIVER
STR-DN1050/STR-DN850

Selecting a sound field (Sound Field)

You can select from a variety of sound field modes according to speaker connections or input sources.

1. Select [Settings] - [Audio Settings] from the home menu.
2. Select [Sound Field].
3. Select the sound field you want.

For details on each sound field, see the following topics.

- [Auto Format Direct \(A.F.D.\)/2-channel sound mode](#)
- [Movie mode](#)
- [Music mode](#)
- [When headphones are connected](#)

Note

- The sound fields for movie and music may not work, depending on the input or the speaker pattern you select, or with audio formats.
- The receiver may play signals at a lower sampling frequency than the actual sampling frequency of the input signals, depending on the audio format.
- [PLIIX Movie] or [PLIIX Music] may not appear, depending on the speaker pattern you select.
- Some speakers or the subwoofer may not output sound, depending on the sound field setting.
- If there is any noise present, the noise may be different, depending on the sound field you select.

Hint

- You can also select [Sound Field] in [Sound Effects] from the home menu.
- You can also use A.F.D./2CH, MOVIE or MUSIC on the remote control or the receiver to select a sound field.

Related Topic

- [Resetting sound fields to the default settings](#)

[Notes on use](#)

4-488-938-11(1)

Copyright 2014 Sony Corporation



MULTI CHANNEL AV RECEIVER
STR-DN1050/STR-DN850

Resetting sound fields to the default settings

Be sure to use the buttons on the receiver to perform this operation.

1. Turn off the receiver.
2. Hold down MUSIC and press $\text{I/}\text{O}$ (on/standby) on the receiver.
[S.F. CLEAR] appears on the display panel and all sound fields are reset to their default setting.

Notes on use

4-488-938-11(1)

Copyright 2014 Sony Corporation

MULTI CHANNEL AV RECEIVER
STR-DN1050/STR-DN850

Adjusting the equalizer (Equalizer)

You can use the following parameters to adjust the tonal quality (bass/treble level) of the front, center, surround/surround back and front high speakers.

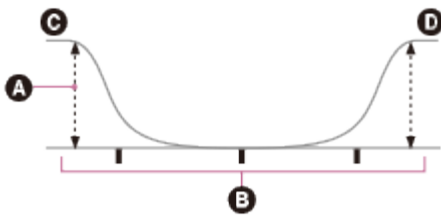

- A** Level (dB)
- B** Frequency (Hz)
- C** Bass
- D** Treble

1. Select [Settings] - [Audio Settings] from the home menu.
2. Select [Equalizer].
3. Select [Front], [Center], [SUR/SB] or [Front High].
4. Select [Bass] or [Treble].
5. Adjust the gain.

Note

- This function does not work when [2ch Analog Direct] is being used.
- Frequencies for [Bass] and [Treble] are fixed.
- Depending on the audio format, the receiver may play signals at a lower sampling frequency than the original sampling frequency of the input signals.

Hint

- You can also select [Equalizer] in [Sound Effects] from the home menu.

Notes on use

4-488-938-11(1)

Copyright 2014 Sony Corporation



MULTI CHANNEL AV RECEIVER
STR-DN1050/STR-DN850

Enjoying clear and dynamic sound at a low volume (Sound Optimizer)

You can enjoy clear and dynamic sound at low volume levels using the Sound Optimizer. After the Auto Calibration is performed, the sound level is optimized to suit your environment.

1. Select [Settings] - [Audio Settings] from the home menu.
2. Select [Sound Optimizer].
3. Select the setting you want.
 - Normal: Adjusts for the reference level of a movie.
 - Low: Adjusts for a CD or other software whose average sound pressure level is processed highly.
 - Off

Note

- This function does not work in the following cases:
 - [2ch Analog Direct] is being used.
 - Headphones are connected.
- The receiver may play signals at a lower sampling frequency than the actual sampling frequency of the input signals, depending on the audio format.

Hint

- You can also select [Sound Optimizer] in [Sound Effects] from the home menu.

Notes on use

4-488-938-11(1)

Copyright 2014 Sony Corporation



MULTI CHANNEL AV RECEIVER
STR-DN1050/STR-DN850

Selecting the Auto Calibration type (Calibration Type)

You can select a calibration type after you have performed the Auto Calibration and saved the settings.

1. Select [Settings] - [Speaker Settings] from the home menu.
2. Select [Calibration Type].
3. Select the setting you want.
 - Full Flat: Makes the measurement of frequency from each speaker flat.
 - Engineer: Sets to “the Sony listening room standard” frequency characteristics.
 - Front Reference : Adjusts the characteristics of all of the speakers to match the characteristics of the front speaker.
 - Off

Note

- This function does not work in the following cases:
 - [2ch Analog Direct] is being used.
 - Headphones are connected.
- The receiver may play signals at a lower sampling frequency than the actual sampling frequency of the input signals, depending on the audio format.

Hint

- You can also select [Calibration Type] in [Sound Effects] from the home menu.

Notes on use

4-488-938-11(1)

Copyright 2014 Sony Corporation



MULTI CHANNEL AV RECEIVER
STR-DN1050/STR-DN850

Enjoying high-fidelity sound (Pure Direct)

You can enjoy higher-fidelity sound from all inputs using the Pure Direct function. When the Pure Direct function is on, the display panel lights off to suppress noise that affects sound quality.

1. Select [Sound Effects] - [Pure Direct] from the home menu.
2. Select [On].

Canceling Pure Direct

The Pure Direct function will be canceled when you perform the following:

- Select [Off] in step 2.
- Press PURE DIRECT on the receiver.
- Change the sound field.
- Change the scene setting on the TV (Scene Select).
- Change the setting of [Equalizer], [Sound Optimizer], [Advanced Auto Volume] or [Dynamic Range Compressor].

Note

- [Equalizer], [Sound Optimizer], [Advanced Auto Volume] and [Dynamic Range Compressor] do not work when the Pure Direct function is selected.

Hint

- You can also use the PURE DIRECT button on the receiver to turn the Pure Direct function on or off.
- You can also select [Pure Direct] in [Settings] - [Audio Settings] from the home menu.

Notes on use

4-488-938-11(1)

Copyright 2014 Sony Corporation



MULTI CHANNEL AV RECEIVER
STR-DN1050/STR-DN850

Overview of network features

- The receiver supports an AirPlay. You can enjoy audio content stored on an iPhone/iPad/iPod or in an iTunes Library.
- The receiver is a DLNA CERTIFIED™ Product.
 - You can enjoy audio content stored on a DLNA-compliant server device (DMS).
 - You can control the receiver from a DLNA-compliant controller (DMC).
- The receiver supports internet music services.

You can enjoy audio content streamed from a music service.
- The receiver supports internet updates.

You can keep the receiver up-to-date with an internet connection.
- You can control the receiver from your mobile device.
 - “TV SideView” is available on Google Play and App Store.
 - “SongPal” is available on Google Play and App Store.

[Notes on use](#)

4-488-938-11(1)

Copyright 2014 Sony Corporation



MULTI CHANNEL AV RECEIVER
STR-DN1050/STR-DN850

Network features message list

Network settings

- Invalid XXX (*):
The entered value is incorrect or invalid.

* XXX represents an SSID, IP Address, Security Key, Subnet Mask, Default Gateway, Primary DNS, or Secondary DNS.

Home Network

- Cannot connect:
The receiver cannot be connected to the selected server.
- Cannot get info:
The receiver cannot retrieve information on the server or contents.
- Cannot play:
The receiver cannot play audio files because the file format is incompatible, the audio files have playback restrictions or there is a read file data error.
- Initialize:
The receiver is restoring the network function to the factory default.
- No server is available:
There is no server on the network that the receiver can connect to. Try refreshing the server list.
- No Track:
There are no playable files in the selected folder on the server.
- Feature currently unavailable.:
An operation that is currently prohibited has been attempted.

Music services

- Cannot connect:
The receiver cannot be connected to the selected server.
- Cannot get info:
The receiver cannot obtain content from the server.
- Cannot play:
 - You tried to play an unplayable file.
 - The receiver cannot play a service or station due to an incompatible file format or playback restrictions.
- Software update is required:
The service is not available in the current version of the receiver software.
Visit the website below for more information on the software update:
[Customer support websites](#)
- No service is available:
There are no service providers.

- Not available:
 - The selected service is not available.
 - An operation that is currently unavailable has been attempted.
- Feature currently unavailable.:
An operation that is currently prohibited has been attempted.

Notes on use

4-488-938-11(1)

Copyright 2014 Sony Corporation



MULTI CHANNEL AV RECEIVER
STR-DN1050/STR-DN850

System requirements for a wired LAN connection

The following system environment is required to use the network function of the receiver via a wired LAN connection.

Broadband connection

A broadband connection to the Internet is required in order to listen to the music services and to update the software of the receiver.

Router

- Use a router compatible with transmission speeds of 100 Mbps or greater to enjoy content on your home network.
- We recommend that you use a router equipped with a built-in DHCP (Dynamic Host Configuration Protocol) server. This function automatically assigns IP addresses to devices on the LAN.

LAN cable (CAT5)

- We recommend using a normal shielded type cable for a wired LAN to avoid electric noise.
- Some flat-type LAN cables are easily affected by noise.

Server

A server is a device which delivers music content to a DLNA device on a home network. A device that can be used as a server (a computer, etc.) must be connected to your wireless or wired LAN home network.

[Notes on use](#)

4-488-938-11(1)

Copyright 2014 Sony Corporation

MULTI CHANNEL AV RECEIVER
STR-DN1050/STR-DN850

Setting up a wired LAN connection

You can set up a wired LAN connection by the following procedure.

1. Select [Settings] - [Network Settings] from the home menu.

2. Select [Internet Settings].

3. Select [Wired] (*).

The screen for selecting the IP address acquisition method is displayed on the TV screen.

* You cannot select [Wired] if a LAN cable is not connected to the receiver.

4. Select [Auto].

5. Select [OK].

The receiver starts connecting to the network. For details, refer to the messages that appear on the TV screen.

If using a fixed IP address

Select [Manual] in step 4. The IP address input display appears on the TV screen.

Enter the value for [IP Address] using the on-screen keyboard. Press **↑** / **↓** / **←** / **→** and **+** to select the characters one by one, then select [Enter] to confirm the values.

Enter the values for [Subnet Mask], [Default Gateway], [Primary DNS] and [Secondary DNS], then select [Next].

Hint

- See [Information] when checking the network settings.

Related Topic

- [Connecting the receiver to the network using a LAN cable \(for wired LAN connections only\)](#)

Notes on use

4-488-938-11(1)

Copyright 2014 Sony Corporation



MULTI CHANNEL AV RECEIVER
STR-DN1050/STR-DN850

System requirements for a wireless LAN connection

The following system environment is required to use the network function of the receiver via a wireless LAN connection.

Broadband connection

A broadband connection to the Internet is required in order to listen to the music services and to update the software of the receiver.

Router

- Use a router compatible with transmission speeds of 100 Mbps or greater to enjoy content on your home network.
- We recommend that you use a router equipped with a built-in DHCP (Dynamic Host Configuration Protocol) server. This function automatically assigns IP addresses on the LAN.

Server

A server is a device which delivers music content to a DLNA device on a home network. A device that can be used as a server (a computer, etc.) must be connected to your wireless or wired LAN home network.

[Notes on use](#)

4-488-938-11(1)

Copyright 2014 Sony Corporation



MULTI CHANNEL AV RECEIVER
STR-DN1050/STR-DN850

Selecting a wireless LAN connection method

You can select the most suitable network connection method for your network environment from four network connection methods. Confirm your network environment in advance.

If your wireless LAN router/access point supports the WPS (Wi-Fi Protected Setup) push button configuration method

If your wireless LAN router/access point has a designated WPS button, see the following topic:

[Method 1: Setting up a wireless network using the WPS push button configuration method](#)

If your wireless LAN router/access point supports the WPS PIN code configuration method

If you have an access point that supports WPS PIN (Personal Identification Number) code connections, see the following topic:

[Method 2: Setting up a wireless network using the WPS PIN code configuration method](#)

If setting up a network connection by searching for your access point

You can search for available access points that are already configured and select a network name (SSID) from the search results. For details, see the following topic:

[Method 3: Setting up a network connection by selecting an access point \(Access Point Scan method\)](#)

If connecting to a new access point

You can add and connect to a new access point by entering a network name (SSID) and security key (WEP key or WPA key) manually without using the WPS method. For details, see the following topic:

[Method 4: Setting up a network connection by adding a new access point \(manual setup method\)](#)

Related Topic

[Connecting the receiver to the network using the wireless LAN antenna \(for wireless LAN connections only\)](#)

MULTI CHANNEL AV RECEIVER
STR-DN1050/STR-DN850

Method 1: Setting up a wireless network using the WPS push button configuration method

If your wireless LAN router/access point has a WPS button, you can easily connect the receiver to a Wi-Fi (wireless LAN) network.

If your wireless LAN router has an AOSS button or other easy setup button, it may support WPS. Check the operation manual of your wireless LAN router/access point for details.

1. Select [Settings] - [Network Settings] from the home menu.
2. Select [Internet Settings].
3. Select [Wireless] (*).
The screen for selecting the IP address acquisition method is displayed on the TV screen.

* You cannot select [Wireless] if a LAN cable is connected to the receiver.

4. Select [WPS Push].
The receiver starts searching for access point, and displays a list of up to 30 available network names (SSIDs).
5. Follow the on-screen instructions, and press the WPS button on the access point.
Message: [Push the WPS button on the access point within 2 minutes.]



- A** WPS button on the wireless LAN router/access point

The receiver starts connecting to the network. For details, refer to the messages that appear on the TV screen. After the network settings are complete, [Wi-Fi icon] lights up on the display panel.

Hint

- WPS (Wi-Fi Protected Setup) is a standard created by the Wi-Fi Alliance allowing you to set up a wireless network easily and securely.
- See [Information] when checking the network settings.

Notes on use

4-488-938-11(1)

Copyright 2014 Sony Corporation

MULTI CHANNEL AV RECEIVER
STR-DN1050/STR-DN850

Method 2: Setting up a wireless network using the WPS PIN code configuration method

You can set up a connection by entering the WPS PIN (Personal Identification Number) code of the receiver into your wireless LAN router/access point to authenticate the connection between the devices.

1. Select [Settings] - [Network Settings] from the home menu.
2. Select [Internet Settings].
3. Select [Wireless] (*).

* You cannot select [Wireless] if a LAN cable is connected to the receiver.

4. Select [Manual Registration].

5. Select [WPS PIN].

A list of available SSIDs (access points) appears.

6. Select the network name (SSID) you want.

The PIN code (8 digits) of the receiver appears on the TV screen. Leave the PIN code displayed until the connection is complete. (A different PIN code is displayed each time you perform this operation.)

7. Input the receiver's PIN code into the wireless LAN router/access point.

The receiver starts connecting to the network. For details, refer to the messages that appear on the TV screen. After the network settings are complete, [Wi-Fi] lights up on the display panel.

Note

- SSIDs that do not support WPS PIN will appear dimmed and cannot be selected in step 5.

Hint

- WPS (Wi-Fi Protected Setup) is a standard created by the Wi-Fi Alliance allowing you to set up a wireless network easily and securely.
- See [Information] when checking the network settings.
- For details on entering the PIN code into the wireless LAN router/access point, refer to the operating instructions of your wireless LAN router/access point.

[Notes on use](#)

MULTI CHANNEL AV RECEIVER
STR-DN1050/STR-DN850

Method 3: Setting up a network connection by selecting an access point (Access Point Scan method)

To set up the network using this connection method, you will be required to select or enter the following information. Check the following information in advance.

Note

- This connection method requires information such as the network name (SSID) (*1) of the wireless LAN router/access point and the security key (password) (*2) for the network.

*1 SSID (Service Set Identifier) is a name that identifies a particular access point.

*2 This information should be available from a label on your wireless LAN router/access point, from the operating instructions, from the person who set up your wireless network, or from the information provided by your Internet service provider.

1. Select [Settings] - [Network Settings] from the home menu.
2. Select [Internet Settings].
3. Select [Wireless] (*).
The screen for selecting the IP address acquisition method is displayed on the TV screen.
* You cannot select [Wireless] if a LAN cable is connected to the receiver.
4. Select [Access Point Scan].
A list of available SSIDs (access points) appears.
5. Select the network name (SSID) you want.
The security setting display appears on the TV screen.
6. Enter the security key (WEP key, WPA/WPA2 key) using the on-screen keyboard. Press **↑** / **↓** / **←** / **→** and **+** to select the characters one by one, then select [Enter] to confirm the security key.
The screen for selecting the IP address acquisition method is displayed on the TV screen.
7. Select [Auto].
8. Select [OK].
The receiver starts connecting to the network. For details, refer to the messages that appear on the TV screen.
After the network settings are complete, [] lights up on the display panel.

If using a fixed IP address

Select [Manual] in step 7. The IP address input display appears on the TV screen.

Enter the value for [IP Address] using the on-screen keyboard. Press **↑** / **↓** / **←** / **→** and **+** to select the characters one by one, then select [Enter] to confirm the value.

Enter the values for [Subnet Mask], [Default Gateway], [Primary DNS] and [Secondary DNS], then select [Next].

Note

- The security setting display in step 6 does not appear if your network has not been secured by encryption (using the security key).

Hint

- See [Information] when checking the network settings.

Notes on use

4-488-938-11(1)

Copyright 2014 Sony Corporation

MULTI CHANNEL AV RECEIVER
STR-DN1050/STR-DN850

Method 4: Setting up a network connection by adding a new access point (manual setup method)

You can input the network name (SSID) you want manually if it does not appear on the list.

1. Select [Settings] - [Network Settings] from the home menu.
2. Select [Internet Settings].
3. Select [Wireless] (*).
* You cannot select [Wireless] if a LAN cable is connected to the receiver.
4. Select [Manual Registration].
5. Select [Direct Input].
6. Enter the network name (SSID) you want using the on-screen keyboard. Press \uparrow / \downarrow / \leftarrow / \rightarrow and \oplus to select the characters one by one, then select [Enter].
The name you entered is registered.
7. Select the security setting you want.
8. Enter the security key (WEP key, WPA/WPA2 key) using the on-screen keyboard. Press \uparrow / \downarrow / \leftarrow / \rightarrow and \oplus to select the characters one by one, then select [Enter] to confirm the security key.
The screen for selecting the IP address acquisition method is displayed on the TV screen.
9. Select [Auto].
10. Select [OK].
The receiver starts connecting to the network. For details, refer to the messages that appear on the TV screen.
After the network settings are complete, [Wi-Fi] lights up on the display panel.

If using a fixed IP address

Select [Manual] in step 9. The IP address input display appears on the TV screen.

Enter the value for [IP Address] using the on-screen keyboard. Press \uparrow / \downarrow / \leftarrow / \rightarrow and \oplus to select the characters one by one, then select [Enter] to confirm the value.

Enter the values for [Subnet Mask], [Default Gateway], [Primary DNS] and [Secondary DNS], then select [Next].

Hint

- See [Information] when checking the network settings.



MULTI CHANNEL AV RECEIVER
STR-DN1050/STR-DN850

Enjoying audio content stored on a server on the home network (DLNA)

You can play back audio content such as DSD, FLAC, WAV, AAC, MP3, etc., stored on a server on the home network using the receiver.

The server may require some settings to be configured to allow the receiver to play audio content from the server. For details, refer to the operating instructions or help of the respective devices or applications.

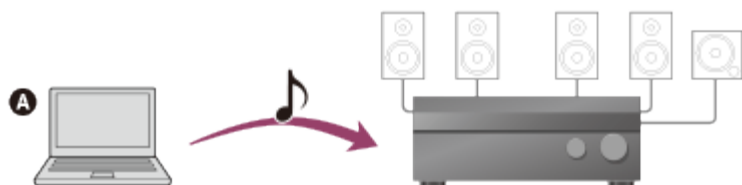

A Server

1. Select [Listen] - [Home Network] from the home menu.
The server list appears on the TV screen.
If the last selected item (playlist, album, folder, etc.) appears on the TV screen, press RETURN to return to the server list.
If [No server is available] appears, press OPTIONS and then select [Refresh] to refresh the server list.
2. Select the server.
The content list appears on the TV screen.
If the server is not available, press OPTIONS and then select [Refresh] to refresh the server list.
3. Select the item (playlist, album, folder, etc.) you want.
Repeat this step to narrow down the choices until the item you want appears. The items that are displayed depend on the server you are connected to.
4. Select the track you want to listen to.
Playback starts.

Note

- Audio content with DRM (Digital Rights Management) copyright protection cannot be played on this receiver.
- There may be some tracks that cannot be played on this receiver.

Hint

- If the server device supports the Wake-on-LAN, the receiver turns the server on automatically in step 2. If the server does not support the Wake-on-LAN, turn on the server in advance. For details on the Wake-on-LAN settings or operations of your server, refer to the operating instructions or help of your server.

- If you select a folder (such as an artist folder, genre folder, etc.) and then press the ►|| button, the receiver plays all items in the selected folder.

Related Topic

- [Compatible formats with DLNA](#)
- [Deleting a server from the server list](#)
- [Cannot connect to the network.](#)
- [A server does not appear in the server list. \(\[No server is available\] appears on the TV screen.\)](#)
- [Playback does not start, or does not automatically proceed to the next track or file.](#)

Notes on use

4-488-938-11(1)

Copyright 2014 Sony Corporation



MULTI CHANNEL AV RECEIVER
STR-DN1050/STR-DN850

Deleting a server from the server list

1. Select [Listen] - [Home Network] from the home menu.
2. Select the server which you want to delete and press OPTIONS.
3. Select [Delete] from the options menu.
4. Select [OK] on the confirmation display.
[Complete!] appears on the display panel, and the selected server is deleted.

Note

- A server will appear in the server list even after being deleted from the list if the receiver finds it on the network (such as when you refresh the server list).

Related Topic

● [Enjoying audio content stored on a server on the home network \(DLNA\)](#)

Notes on use

4-488-938-11(1)

Copyright 2014 Sony Corporation



MULTI CHANNEL AV RECEIVER
STR-DN1050/STR-DN850

Setting whether to control this receiver from a device on the home network (DLNA Control Permission)

You can set whether or not to control this receiver from an individual device on the device list. Only devices set to [Permit] can control this receiver through the home network.

1. Select [Settings] - [Network Settings] from the home menu.
2. Select [DLNA Control Permission].
3. Select [Allow All Controllers].
4. Select [Off].
5. Select the device you want.
6. Select [Set].
7. Select [Permit] or [Disable].

Note

- Up to 20 devices can be set with either [Permit] or [Disable]. When 20 devices have been set, the newest device cannot be set. In this case, delete unnecessary devices from the list.

Related Topic

- [Deleting devices from the device list in DLNA Control Permission](#)

Notes on use

4-488-938-11(1)

Copyright 2014 Sony Corporation

MULTI CHANNEL AV RECEIVER
STR-DN1050/STR-DN850

Enjoying music services offered on the Internet

You can listen to music services offered on the Internet with this receiver.

To use this function, the receiver must be connected to the Internet.

Visit the website below for more information on the music services:

<http://www.sonyentertainmentnetwork.com>

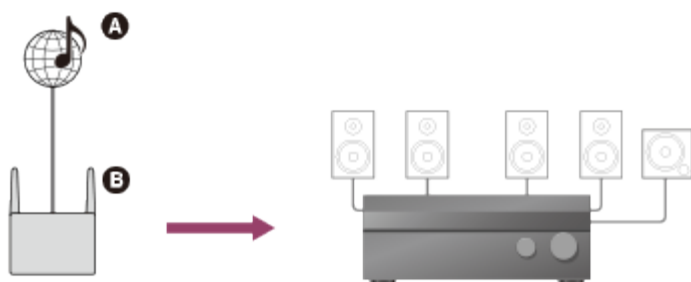

A Internet

B Router

Note

- You may have to register your receiver before using some music services. For details on registration, visit the customer support site of the service provider.

1. Select [Listen] - [Music Services] from the home menu.

The service provider list appears on the TV screen. If the receiver automatically displays the last selected service or station, press RETURN repeatedly until the service provider list appears.

2. Select the music service you want.

Press RETURN to go to the previous directory.

Controlling the music services using the remote control

- Changing the station or service:

Press RETURN to return to the service provider list, then select the service again or select another service.

To return to the playback display, press OPTIONS and select [Now Playing].

- Using various functions while the receiver is selecting or playing a station or service:

Press OPTIONS. The displayed items may vary according to the selected item or directory.

- Select the service options:

While selecting or playing content in the service, press OPTIONS and select [Service Options]. The service options vary depending on the selected services.

Note

- If [No service is available] appears, press OPTIONS and select [Refresh].

Hint

- The receiver displays the last selected service or station when the function is changed to the music services until the receiver is turned off.

Related Topic

- [Registering a new music service](#)

Notes on use

4-488-938-11(1)

Copyright 2014 Sony Corporation



MULTI CHANNEL AV RECEIVER
STR-DN1050/STR-DN850

Registering a new music service

You can enjoy listening to content from a variety of music services offered on the Internet.

Visit the website below for more information on music services, how to enjoy services, and the registration code of the receiver.

<http://munlimited.com/home>

Checking the registration code

You may be required to enter the registration code of the receiver when you enjoy a new music service.

1. Select [Listen] - [Music Services] from the home menu.

The service provider list appears on the TV screen. If the receiver automatically displays the last selected service or station, press RETURN repeatedly until the service provider list appears.

2. Select [Registration Code].

The registration code of the receiver appears.

Note

- Before disposing of the receiver, clear all memorized settings. For details, see “[Reverting to the factory default settings.](#)”
- If you use Music Unlimited, visit the website below and deregister the receiver.
<http://munlimited.com/home>

[Notes on use](#)

4-488-938-11(1)

Copyright 2014 Sony Corporation

MULTI CHANNEL AV RECEIVER
STR-DN1050/STR-DN850

Registering a TV SideView device to the receiver

You can control the receiver by touch-pad operation of a mobile device, tablet device, etc. with TV SideView installed. You need to register your mobile device to the receiver as a remote device (for the first time only).

1. Select [Settings] - [Network Settings] from the home menu.
2. Select [TV SideView Setup].
3. Select [Registration of Devices].
4. Select [Start].
The receiver starts to detect TV SideView devices.
Operate the TV SideView device to be registered. Please note that the receiver will exit the registration if no device is detected in 30 seconds.
5. Select [Finish].

Checking/deleting registered devices

For details, see the following topics:

- [Checking registered TV SideView devices \(TV SideView Setup\)](#)
- [Deleting registered TV SideView devices from the device list](#)

Note

- Up to five TV SideView devices can be registered to the device list. If five devices have already been registered, the device cannot be added to the list. In this case, delete unnecessary devices from the list.
- To start DLNA playback from the TV SideView device, the device needs to be able to control the receiver in [DLNA Control Permission]. For details, see "[Setting control permissions to all devices on the home network \(DLNA Control Permission\)](#)."

Hint

- Download TV SideView from one of the following services according to your mobile device:
 - Google Play (for mobile devices Android OS)
 - App Store (for iPhone or iPad)

Related Topic

- [Setting control permissions to all devices on the home network \(DLNA Control Permission\)](#)
- [Setting whether to control this receiver from a device on the home network \(DLNA Control Permission\)](#)

MULTI CHANNEL AV RECEIVER
STR-DN1050/STR-DN850

Controlling the receiver using a smartphone or tablet device (SongPal)

“SongPal” enhances music visually with your smartphone display. You can choose music/audio contents from integrated functions of various device and smartphone, and control various settings intuitively.

A dedicated App for this model is available on both Google Play and App Store.

Search for “SongPal” and download the free App to find out more about the convenient features.

Easy Control app, “SongPal”, supports wireless operation. It allows you to:

- choose music/audio contents from integrated functions of various devices and smartphone.
- control various settings intuitively.
- enhance the music visually with your smartphone display.

1. Download the “SongPal” application to your mobile device.
2. Run “SongPal” and follow the on-screen instructions.
3. Connect your mobile device to the receiver using the NFC function or by manual operation.
After the connection is completed, you can control the receiver using “SongPal.”

Note

- “SongPal” does not support the iPad.

Related Topic

- [Notes on iPhone/iPod](#)
- [Compatible BLUETOOTH version and profiles](#)
- [Enjoying audio content stored on a BLUETOOTH device with a one-touch connection \(NFC\)](#)
- [Connecting the receiver to the network using a LAN cable \(for wired LAN connections only\)](#)
- [Connecting the receiver to the network using the wireless LAN antenna \(for wireless LAN connections only\)](#)
- [Turning on the control mode for maintenance \(External Control\)](#)

[Notes on use](#)

4-488-938-11(1)

Copyright 2014 Sony Corporation



MULTI CHANNEL AV RECEIVER
STR-DN1050/STR-DN850

Setting control permissions to all devices on the home network (DLNA Control Permission)

1. Select [Settings] - [Network Settings] from the home menu.
2. Select [DLNA Control Permission].
3. Select [Allow All Controllers].
4. Select [On].

Related Topic

- [Setting whether to control this receiver from a device on the home network \(DLNA Control Permission\)](#)

Notes on use

4-488-938-11(1)

Copyright 2014 Sony Corporation



MULTI CHANNEL AV RECEIVER
STR-DN1050/STR-DN850

Compatible BLUETOOTH version and profiles

“Profile” refers to a standard set of capabilities for various BLUETOOTH product capabilities. This receiver supports the following BLUETOOTH version and profiles:

- Compatible BLUETOOTH version: BLUETOOTH Specification Version 3.0
- Compatible BLUETOOTH profiles:
 - A2DP (Advanced Audio Distribution Profile): Receives high-quality audio content.
 - AVRCP 1.3 (Audio Video Remote Control Profile): Controls audio/video devices (pausing, stopping, starting playback, volume control, etc.) for the latest information about compatible BLUETOOTH devices.

Check the websites listed under “[Customer support websites](#).”

Note

- To use the BLUETOOTH function, the BLUETOOTH device to be connected must support the same profile as this receiver. Even if the device supports the same profile, the functions may differ depending on the specifications of the BLUETOOTH device.
- The audio playback on this receiver may be delayed from that on the BLUETOOTH device because of the characteristics of the BLUETOOTH wireless technology.

Notes on use

4-488-938-11(1)

Copyright 2014 Sony Corporation



MULTI CHANNEL AV RECEIVER
STR-DN1050/STR-DN850

Turning the BLUETOOTH function on/off (Bluetooth Power)

You can turn the BLUETOOTH function on or off. The NFC function is also turned on/off in conjunction with this setting.

1. Select [Settings] - [Bluetooth Settings] from the home menu.
2. Select [Bluetooth Power].
3. Select [On] or [Off].

[Notes on use](#)

4-488-938-11(1)

Copyright 2014 Sony Corporation

MULTI CHANNEL AV RECEIVER
STR-DN1050/STR-DN850

Enjoying audio content stored on a BLUETOOTH device with a one-touch connection (NFC)

You can enjoy audio content on a BLUETOOTH device with a one-touch connection using the NFC function.

1. Download the NFC Easy Connect application to your mobile device.



You do not need to install the NFC Easy Connect application if you are using an NFC-compatible mobile device with Android OS 4.1 or later installed.

2. Touch the  mark on the receiver with your mobile device.

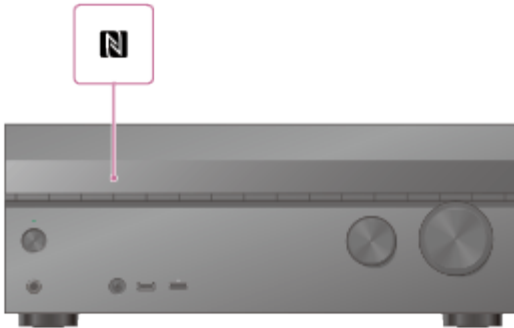

3. Check that the connection is completed and [BT] lights up on the display panel.
4. Start playback on the BLUETOOTH device.
5. Adjust the volume.
Adjust the volume of the BLUETOOTH device first. If the volume level is still too low, adjust the volume level of the receiver.

Compatible smartphones

Smartphones with the NFC function (compatible OS: Android 2.3.3 or later)

Related Topic

- [Controlling a BLUETOOTH device using the remote control](#)

- Checking the information of a connected BLUETOOTH device
- Setting the Bluetooth Standby mode (Bluetooth Standby)
- Setting BLUETOOTH audio codecs (Bluetooth AAC/Bluetooth aptX)

Notes on use

4-488-938-11(1)

Copyright 2014 Sony Corporation



MULTI CHANNEL AV RECEIVER
STR-DN1050/STR-DN850

Controlling a BLUETOOTH device using the remote control

You can operate a BLUETOOTH device using the following buttons on the remote control:

- (*): Starts or pauses playback.
- : Stops playback.
- : Moves to the start of the previous/current or next track.

* If you press when no BLUETOOTH device is connected, the receiver automatically connects to the last connected BLUETOOTH device and plays the music on that device.

Note

- These operations may not be available for certain BLUETOOTH devices. The actual operations may also differ depending on the connected BLUETOOTH device.

Related Topic

- [Checking the information of a connected BLUETOOTH device](#)
- [Setting the Bluetooth Standby mode \(Bluetooth Standby\)](#)
- [Setting BLUETOOTH audio codecs \(Bluetooth AAC/Bluetooth aptX\)](#)

Notes on use

4-488-938-11(1)

Copyright 2014 Sony Corporation



MULTI CHANNEL AV RECEIVER
STR-DN1050/STR-DN850

Setting the speakers for zone 2 (for STR-DN1050 only)

When the speakers in zone 2 are connected to the SPEAKERS SURROUND BACK/BI-AMP/FRONT HIGH/FRONT B/ZONE 2 terminals of the receiver, configure the settings so that the sound selected in zone 2 is output from the speakers connected to the SPEAKERS SURROUND BACK/BI-AMP/FRONT HIGH/FRONT B/ZONE 2 terminals.

1. Select [Settings] - [Speaker Settings] from the home menu.
2. Select [Speaker Connection].
3. Set a speaker pattern without surround back and front high speakers.
4. Select [SB Speaker Assign] - [Zone2].

Note

- If a speaker pattern with surround back speakers or front high speakers is set, you cannot set the SPEAKERS SURROUND BACK/BI-AMP/FRONT HIGH/FRONT B/ZONE 2 terminals for a bi-amplifier connection or a zone 2 connection.

Notes on use

4-488-938-11(1)

Copyright 2014 Sony Corporation

MULTI CHANNEL AV RECEIVER
STR-DN1050/STR-DN850

Operating the receiver for zone 2 (for STR-DN1050 only)

You can enjoy sound from the receiver in zone 2 by the following procedure.

1. Turn on the amplifier in zone 2.
In the case of "[Connecting the speakers in zone 2 \(for STR-DN1050 only\)](#)," skip this step.
2. Press ZONE POWER on the receiver.
The zone function is activated.
3. Press ZONE CONTROL on the receiver.
4. Select the source signals you want to output using INPUT SELECTOR on the receiver while [2. xxxx (input name)] is shown on the display panel.
5. Adjust to a suitable volume.
 - In the case of "[Connecting the speakers in zone 2 \(for STR-DN1050 only\)](#)," adjust the volume using MASTER VOLUME on the receiver while [2. xxxx (input name)] is shown on the display panel.
 - In the case of "[Connecting another amplifier in zone 2 \(for STR-DN1050 only\)](#)," adjust the volume using the receiver in zone 2. If you set [Lineout] for [Zone2] to [Variable], you can also adjust the volume in zone 2 using MASTER VOLUME on the receiver while [2. xxxx (input name)] is shown on the display panel.

Exiting zone 2 operation

Press ZONE POWER.

Available input for zone 2 operations

- SOURCE (*1)
- BD/DVD
- GAME
- SAT/CATV
- VIDEO 1
- VIDEO 2
- SA-CD/CD
- TUNER (*2)
- USB (*3)
- Bluetooth
- Home Network (*3)
- Music Services (*3)

*1 The signals of the current input in main zone are output when [SOURCE] is selected.

*2 You can select either [FM TUNER] or [AM TUNER] from the main zone and zone 2. Priority is given to the choice which has most recently been selected, even if a different choice has already been selected in one of the zones.

*3 You can select either [USB], [Home Network], or [Music Services] from the main zone and zone 2. Priority is given to the choice which has most recently been selected, even if a different choice has already been selected in one of the zones.

Note

- When the receiver is in standby mode, the I/O (on/standby) indicator on the front panel lights up in amber if the receiver in zone 2 is turned on.
- AirPlay function is available in main zone only.

Related Topic

- [Turning on/off the power for zone 2 \(Power\) \(for STR-DN1050 only\)](#)
- [Selecting the source signals for zone 2 \(Input\) \(for STR-DN1050 only\)](#)
- [Adjusting the volume for zone 2 \(Volume\) \(for STR-DN1050 only\)](#)
- [Setting the volume control for zone 2 \(Lineout\) \(for STR-DN1050 only\)](#)

Notes on use

4-488-938-11(1)

Copyright 2014 Sony Corporation

Setting the volume control for zone 2 (Lineout) (for STR-DN1050 only)

You can set variable or fixed volume control for the ZONE 2 AUDIO OUT jacks.

1. Select [Settings] - [Zone Settings] from the home menu.
2. Select [Lineout].
3. Select the setting you want.
 - Variable:
Recommended when using another amplifier that does not have volume control for zone 2.
The volume for the ZONE 2 AUDIO OUT jacks can be changed.
 - Fixed:
Recommended when using another amplifier with variable volume control for zone 2. The volume for the ZONE 2 AUDIO OUT jacks is fixed.

Note

- When [Variable] is set, the volume is turned down by default. Turn up the volume while listening to the sound after completing setup. The volume for the SPEAKERS SURROUND BACK/BI-AMP/FRONT HIGH/FRONT B/ZONE 2 terminals is changed together with the volume for the ZONE 2 AUDIO OUT jacks.

Notes on use

4-488-938-11(1)

Copyright 2014 Sony Corporation



MULTI CHANNEL AV RECEIVER
STR-DN1050/STR-DN850

Setting the zone 2 HDMI output (Zone2 Out) (for STR-DN1050 only)

When a device such as a TV or AV amplifier is connected to the HDMI ZONE 2 OUT jack, you can output HDMI signals from the device in zone 2. For details, see “Connecting another amplifier using the HDMI ZONE 2 OUT jack” in [“Connecting another amplifier in zone 2 \(for STR-DN1050 only\).”](#)

1. Select [Settings] - [HDMI Settings] from the home menu.
2. Set [Zone2 Out] to [On].

Note

- When the Zone2 Out function is enabled, the following functions are disabled:
 - Control for HDMI (“BRAVIA” Sync)
 - Fast View

Notes on use

4-488-938-11(1)

Copyright 2014 Sony Corporation



MULTI CHANNEL AV RECEIVER
STR-DN1050/STR-DN850

Setting the priority for the main zone (Priority) (for STR-DN1050 only)

When the Zone2 Out function is enabled and you select the same HDMI input for both the main zone and zone 2, there may be some interference to the audio and video signals in the main zone. To avoid possible interference, you can place priority on the main zone for HDMI input selection.

1. Select [Settings] - [HDMI Settings] from the home menu.
2. Set [Priority] to [Main Only].

Hint

- If you connect TVs that have different resolutions to the main zone and zone 2 but select the same HDMI input for both zones, the video signals output to each TV are limited to a lower resolution than those of the TVs.

[Notes on use](#)

4-488-938-11(1)

Copyright 2014 Sony Corporation



MULTI CHANNEL AV RECEIVER
STR-DN1050/STR-DN850

What is “BRAVIA” Sync?

The “BRAVIA” Sync function allows communication between Sony products such as TVs, Blu-ray Disc players, DVD players, and AV amplifiers that support the Control for HDMI function.

Control for HDMI is a mutual control function standard used by HDMI CEC (Consumer Electronics Control) for HDMI (High-Definition Multimedia Interface).

We recommend that you connect the receiver to products featuring “BRAVIA” Sync.

[Notes on use](#)

4-488-938-11(1)

Copyright 2014 Sony Corporation



MULTI CHANNEL AV RECEIVER
STR-DN1050/STR-DN850

Preparing for “BRAVIA” Sync

Turn on the Control for HDMI function of the receiver and the connected device to individually.

1. Select [Settings] - [HDMI Settings] from the home menu.
2. Select [Control for HDMI].
3. Select [On].
The Control for HDMI function of the receiver is turned on.
4. Press HOME to exit the GUI menu.
5. Select the HDMI input of the receiver and TV to match the HDMI input of the connected device, so that the image from the connected device is displayed.
6. Turn on the Control for HDMI function of the connected device.
For details on setting the TV and connected device, refer to the operating instructions of the respective devices.
7. Repeat steps 5 and 6 for other devices for which you want to use the Control for HDMI function.

Note

- Perform the steps above again if you unplug the HDMI cable or change the connection.

Notes on use

4-488-938-11(1)

Copyright 2014 Sony Corporation



MULTI CHANNEL AV RECEIVER
STR-DN1050/STR-DN850

Interlocking other devices using an HDMI connection (“BRAVIA” Sync)

By connecting Sony devices that support the “BRAVIA” Sync using an HDMI cable (not supplied), operations are simplified as follows:

- [Enjoying an input source from a connected device immediately \(One-Touch Play\)](#)
- [Enjoying TV sound from the speakers connected to the receiver \(System Audio Control\)](#)
- [Turning off the receiver and connected devices simultaneously with the TV \(System Power Off\)](#)
- [Selecting the optimum picture quality and sound field automatically \(Scene Select\)](#)
- [Home Theatre Control](#)
- [Operating the receiver menu using the TV remote control \(Remote Easy Control\)](#)
- [Controlling MHL devices](#)

Note

- The “One-Touch Play,” “System Audio Control,” and “System Power Off” functions can be used with non-Sony devices. However, compatibility with all non-Sony devices is not guaranteed.
- The “Scene Select” and “Home Theatre Control” functions are Sony proprietary functions. These cannot operate with non-Sony devices.
- Devices incompatible with “BRAVIA” Sync cannot activate these features.
- The Control for HDMI function does not work on devices connected to the HDMI OUT B jack of the receiver (for STR-DN1050 only).
- Some of the operations may be supported when you connect an MHL device.

Notes on use

4-488-938-11(1)

Copyright 2014 Sony Corporation

MULTI CHANNEL AV RECEIVER
STR-DN1050/STR-DN850

Enjoying sound of TV broadcasts from the receiver

If your TV supports the Audio Return Channel (ARC) function, set the receiver by the following procedure to output the sound of the TV from the speakers connected to the receiver.

1. Select [Settings] - [HDMI Settings] from the home menu.
2. Select [Control for HDMI].
3. Select [On].

If you connect to a TV that is not compatible with the Audio Return Channel (ARC) function or you want to select an audio signal using a cable other than an HDMI cable (e.g. via an optical digital cable or an audio cable)

Switch the audio input mode. For details, see “[Switching between digital and analog audio \(Input Mode\)](#).”

Note

- Be sure to turn off the volume of the TV or activate the muting function of the TV.
- If your TV does not support the System Audio Control function, set [Audio Out] to [TV+AMP] in the HDMI Settings menu to output the sound of the TV from the TV speaker and the speakers connected to the receiver.

Related Topic

- [Switching between digital and analog audio \(Input Mode\)](#)
- [Connecting a TV \(for STR-DN1050\)](#)
- [Connecting a TV \(for STR-DN850\)](#)

[Notes on use](#)

4-488-938-11(1)

Copyright 2014 Sony Corporation



MULTI CHANNEL AV RECEIVER
STR-DN1050/STR-DN850

Switching the monitors that output the HDMI video signals (for STR-DN1050 only)

If you have connected two monitors to the HDMI OUT A and HDMI OUT B jacks, you can switch the output for these two monitors using the HDMI OUTPUT button on the remote control.

1. Turn on the receiver and the two monitors.
2. Press HDMI OUTPUT.

Each time you press the button, the output will be switched as follows:

HDMI A - HDMI B - HDMI A + B - HDMI OFF

Note

- [HDMI A + B] may not work if the compatible video formats of the monitors connected to the HDMI OUT A jack and the HDMI OUT B jack of the receiver are different.
- [HDMI A + B] may not work depending on the playback device you connect.

[Notes on use](#)

4-488-938-11(1)

Copyright 2014 Sony Corporation



MULTI CHANNEL AV RECEIVER
STR-DN1050/STR-DN850

Switching between digital and analog audio (Input Mode)

When you connect devices to both digital and analog audio input jacks on the receiver, you can fix the audio input mode to either device, or switch from one to the other, depending on the type of material you intend to watch.

1. Press the input buttons to select the input.
2. Press OPTIONS.
3. Select [Input Mode].
 - Auto: Gives priority to digital audio signals. If there is more than one digital connection, HDMI audio signals have priority.
If there is no digital audio signals, analog audio signals are selected. When TV input is selected, priority is given to Audio Return Channel (ARC) signals. If your TV supports the ARC function, digital optical audio signals are selected.
 - Optical: Specifies input of digital audio signals to the OPTICAL jack.
 - Coaxial: Specifies input of digital audio signals to the COAXIAL jack.
 - Analog: Specifies input of analog audio signals to the AUDIO IN (L/R) jacks.

Note

- Depending on the input, [Input Mode] may be dimmed on the TV screen and other modes cannot be selected.
- When [2ch Analog Direct] is being used, audio input is set to [Analog]. You cannot select other modes.

Hint

- You can also use INPUT SELECTOR on the receiver to select the input in step 1.

Notes on use

4-488-938-11(1)

Copyright 2014 Sony Corporation

MULTI CHANNEL AV RECEIVER
STR-DN1050/STR-DN850

Using other video/audio input jacks (Input Assign)

You can reassign the COMPONENT VIDEO (*) and OPTICAL/COAXIAL digital audio input jacks to other input if the default settings of the jacks do not correspond to your connected device.

E.g. When connecting a DVD player to the OPTICAL IN 1 (SAT/CATV) and COMPONENT VIDEO IN 1 (SAT/CATV) jacks of the STR-DN1050:

- Assign the OPTICAL IN 1 (SAT/CATV) jack to [BD/DVD].
 - Assign the COMPONENT VIDEO IN 1 (SAT/CATV) jacks to [BD/DVD].
1. Select [Settings] - [Input Settings] from the home menu.
 2. Select the input name you want to assign.
 3. Press ←/→ repeatedly to select [COMPONENT] (*) or [OPT/COAX].
 4. Press ↑/↓ repeatedly to select the jack you want to assign.

* For STR-DN1050 only

Assignable video input jacks (for STR-DN1050 only)

IN 2:

BD/DVD, GAME (*), SAT/CATV, VIDEO 1, VIDEO 2, SA-CD/CD

IN 1:

BD/DVD, GAME, SAT/CATV (*), VIDEO 1, VIDEO 2, SA-CD/CD

None:

BD/DVD (*), GAME, SAT/CATV, VIDEO 1 (*), VIDEO 2 (*), SA-CD/CD (*)

Assignable audio input jacks

OPT 2:

STR-DN1050: BD/DVD, GAME, SAT/CATV, VIDEO 1, VIDEO 2, SA-CD/CD

STR-DN850: BD/DVD, GAME, SAT/CATV, VIDEO, SA-CD/CD

OPT 1:

STR-DN1050: BD/DVD, GAME, SAT/CATV (*), VIDEO 1, VIDEO 2, SA-CD/CD

STR-DN850: BD/DVD, GAME, SAT/CATV (*), VIDEO, SA-CD/CD

COAX:

STR-DN1050: BD/DVD (*), GAME, SAT/CATV, VIDEO 1, VIDEO 2, SA-CD/CD

STR-DN850: BD/DVD, GAME, SAT/CATV, VIDEO, SA-CD/CD (*)

None:

STR-DN1050: BD/DVD, GAME (*), SAT/CATV, VIDEO 1 (*), VIDEO 2 (*), SA-CD/CD (*)

STR-DN850: BD/DVD (*), GAME (*), SAT/CATV, VIDEO (*), SA-CD/CD

* Default setting

Note

- When you assign the digital audio input, the Input Mode setting may change automatically.
- One reassignment is allowed for each input.
- If no sound is output from the assigned jacks, also check the Input Mode settings.

Notes on use

4-488-938-11(1)

Copyright 2014 Sony Corporation



MULTI CHANNEL AV RECEIVER
STR-DN1050/STR-DN850

About Custom Preset

You can save various settings with the player, monitor, etc., according to your listening and viewing style. You can register those settings for “one-touch” operation, and then recall the environment created with the settings easily. For example, by saving the settings in the [1: Movie] preset as follows, you can switch the settings of the receiver all at one time without switching each setting for [Input], [Calibration Type], and [Sound Field] individually.

- Input: BD/DVD
- Sound Field: HD-D.C.S.
- Calibration Type: No Change

[Notes on use](#)

4-488-938-11(1)

Copyright 2014 Sony Corporation



MULTI CHANNEL AV RECEIVER
STR-DN1050/STR-DN850

Recalling the settings saved to the scene

1. Select [Custom Preset] from the home menu.
2. Select a preset you want.

Hint

- You can recall the setting(s) saved for [1: Movie], [2: Music] or [3: Party] directly by pressing CUSTOM PRESET 1, CUSTOM PRESET 2, or CUSTOM PRESET 3 on the remote control.

Related Topic

- [Items for which you can save settings and the default values for each item](#)

Notes on use

4-488-938-11(1)

Copyright 2014 Sony Corporation

Saving the settings to a preset

1. Select [Custom Preset] from the home menu.
2. Press OPTIONS with a preset for which you want to edit settings among from [1: Movie], [2: Music], [3: Party] or [4: Night] selected.
3. Select the menu you want from the options menu.
 - Edit:
Allows you to customize and save the settings to suit your preferences.
 - Import:
Loads the present settings of the receiver and saves those settings with the preset. [Input] and [Volume] are set to [No Change].

Note

- Settings items saved as [No Change] are not changed from the present settings even when you recall the preset. Select [Edit], then uncheck the box for a setting item on the edit screen to set [No Change].

Hint

- You can overwrite [1: Movie], [2: Music], or [3: Party] with the present settings by holding down CUSTOM PRESET 1, CUSTOM PRESET 2 or CUSTOM PRESET 3 for 3 seconds in the same way as you do when you select [Import] from the menu.
- When you select [3: Party], zone 2 is turned on automatically and you can simultaneously enjoy the same music as the main zone.

Related Topic

- [Items for which you can save settings and the default values for each item](#)

Notes on use

4-488-938-11(1)

Copyright 2014 Sony Corporation



MULTI CHANNEL AV RECEIVER
STR-DN1050/STR-DN850

Items for which you can save settings and the default values for each item

1: Movie

- Input: BD/DVD
- Tuner Preset: No Change
- Volume: No Change
- HDMI OUT: No Change
- Party Mode (for STR-DN1050 only): No Change
- Sleep: No Change
- Sound Field: HD-D.C.S.
- Sound Optimizer: No Change
- Pure Direct: No Change
- Calibration Type: No Change
- Front Bass: No Change
- Front Treble: No Change
- Center Bass: No Change
- Center Treble: No Change
- SUR/SB Bass: No Change
- SUR/SB Treble: No Change
- Front High Bass: No Change
- Front High Treble: No Change

2: Music

- Input: SA-CD/CD
- Tuner Preset: No Change
- Volume: No Change
- HDMI OUT: No Change
- Party Mode (for STR-DN1050 only): No Change
- Sleep: No Change
- Sound Field: Berlin Philharmonic Hall
- Sound Optimizer: No Change
- Pure Direct: No Change
- Calibration Type: No Change
- Front Bass: No Change
- Front Treble: No Change
- Center Bass: No Change
- Center Treble: No Change
- SUR/SB Bass: No Change
- SUR/SB Treble: No Change

- Front High Bass: No Change
- Front High Treble: No Change

3: Party

- Input: No Change
- Tuner Preset: No Change
- Volume: 27
- HDMI OUT: No Change
- Party Mode (for STR-DN1050 only): On
- Sleep: Off
- Sound Field: Multi Stereo
- Sound Optimizer: Off
- Pure Direct: No Change
- Calibration Type: No Change
- Front Bass: No Change
- Front Treble: No Change
- Center Bass: No Change
- Center Treble: No Change
- SUR/SB Bass: No Change
- SUR/SB Treble: No Change
- Front High Bass: No Change
- Front High Treble: No Change

4: Night

- Input: No Change
- Tuner Preset: No Change
- Volume: 11
- HDMI OUT: No Change
- Party Mode (for STR-DN1050 only): No Change
- Sleep: 30 min
- Sound Field: No Change
- Sound Optimizer: Normal
- Pure Direct: No Change
- Calibration Type: No Change
- Front Bass: No Change
- Front Treble: No Change
- Center Bass: No Change
- Center Treble: No Change
- SUR/SB Bass: No Change
- SUR/SB Treble: No Change
- Front High Bass: No Change
- Front High Treble: No Change



MULTI CHANNEL AV RECEIVER
STR-DN1050/STR-DN850

Adjusting the sound balance automatically (Auto Calibration)

This receiver is equipped with a D.C.A.C. (Digital Cinema Auto Calibration) function which allows you to perform automatic calibration. For details on performing this function, see the following topics:

- [Before you perform Auto Calibration](#)
- [Connecting the optimizer microphone](#)
- [Selecting the front speakers](#)
- [Performing Auto Calibration](#)

Related Topic

- [About Auto Calibration](#)
- [Confirming active subwoofer setup](#)

Notes on use

4-488-938-11(1)

Copyright 2014 Sony Corporation

MULTI CHANNEL AV RECEIVER
STR-DN1050/STR-DN850

Using bi-amplifier connections

If you are not using surround back speakers or front high speakers, you can connect the front speakers to the SPEAKERS SURROUND BACK/BI-AMP/FRONT HIGH/FRONT B terminals using a bi-amplifier connection. STR-DN850 is used for illustration purpose in this section.

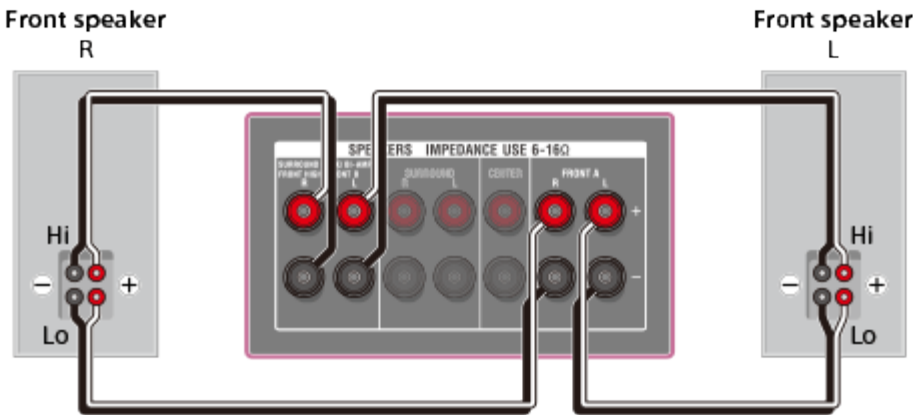

Connect the jacks on the Lo (or Hi) side of the front speakers to the SPEAKERS FRONT A terminals, and connect the jacks on the Hi (or Lo) side of the front speakers to the SPEAKERS SURROUND BACK/BI-AMP/FRONT HIGH/FRONT B terminals.

Make sure that metal fittings of Hi/Lo attached to the speakers have been removed from the speakers to avoid receiver malfunction.

After you have made the bi-amplifier connection, set [SB Speaker Assign] in the Speaker Settings menu to [Bi-Amp].

Note

- You can only set [SB Speaker Assign] if the speaker pattern is set to a setting that does not have surround back and front high speakers.

Related Topic

- [Notes on connecting cables](#)

[Notes on use](#)

4-488-938-11(1)

Copyright 2014 Sony Corporation



MULTI CHANNEL AV RECEIVER
STR-DN1050/STR-DN850

Using the sleep timer

You can set the receiver to turn off automatically at a specified time using the menu on the display panel.

1. Press AMP MENU.

The menu is displayed on the display panel of the receiver.

2. Select [SYSTEM] on the display panel.

3. Select [SLEEP] on the display panel.

4. Press \uparrow / \downarrow to set specified time.

Each time you press \uparrow / \downarrow , the display on the display panel changes cyclically as follows:

OFF - 0:30:00 - 1:00:00 - 1:30:00 - 2:00:00

[SLEEP] lights up on the display panel of the receiver when sleep timer is being used.

Hint

- To check the remaining time before the receiver turns off, repeat steps 1 to 4. The remaining time appears on the display panel.
- The sleep timer will be canceled if you perform the following:
 - Update the software of the receiver.
 - Press \mathcal{P} (on/standby).

Notes on use

4-488-938-11(1)

Copyright 2014 Sony Corporation



MULTI CHANNEL AV RECEIVER
STR-DN1050/STR-DN850

Viewing information on the display panel

The display panel provides various information on the status of the receiver, such as the sound field.

1. Select the input for which you want to check information.

2. Press DISPLAY repeatedly.

Each time you press DISPLAY, the display will change cyclically as follows:

Index name of the input (*1) - Input you selected - Sound field currently applied (*2) - Volume level - Stream information (*3)

When listening to FM and AM radio

Preset station name (*1) - Frequency - Sound field currently applied (*2) - Volume level

When receiving RDS broadcasts (for European and Australian models only)

Program service name or preset station name (*1) - Frequency, band and preset number - Sound field currently applied (*2) - Volume level

*1 Index name appears only when you have assigned one to the input or preset station. Index name does not appear if only blank spaces have been entered or it is same as the input name.

*2 [PURE.DIRECT] appears on the display panel when the Pure Direct function is activated.

*3 Stream information may not be displayed.

Note

- Characters or marks in some languages may not be displayed.

Notes on use

4-488-938-11(1)

Copyright 2014 Sony Corporation

MULTI CHANNEL AV RECEIVER
STR-DN1050/STR-DN850

Performing Auto Calibration

You can perform automatic calibration from where you are sitting.

1. Select [Settings] - [Speaker Settings] from the home menu.
2. Select [Auto Calibration].
3. Follow the instructions on the TV screen, then press **+** to select [Start].
The measurement starts in 5 seconds.
The measurement process will take approximately 30 seconds with a test tone.
When the measurement ends, a beep sounds and the screen switches.
4. Select the item you want.
 - Save: Saves the measurement results and exits the setting process.
 - Retry: Performs the Auto Calibration again.
 - Discard: Exits the setting process without saving the measurement results.For details on the measurement results, see [“Checking Auto Calibration results.”](#)
5. Save the measurement results.
Select [Save] in step 4.

Note

- If an error code or warning message appears on the screen in step 3, see [“List of messages after Auto Calibration measurements.”](#)
- This setting is not available when headphones are connected.

Hint

- The Auto Calibration function will be canceled if you perform the following during the measurement process:
 - Press **1/0**.
 - Press the input buttons on the remote control or turn INPUT SELECTOR on the receiver.
 - Press **⊗**.
 - Press SPEAKERS on the receiver.
 - Change the volume level.
 - Connect headphones.

Related Topic

- [About Auto Calibration](#)

- Before you perform Auto Calibration

- Checking Auto Calibration results

Notes on use

4-488-938-11(1)

Copyright 2014 Sony Corporation



MULTI CHANNEL AV RECEIVER
STR-DN1050/STR-DN850

Calibrating the phase characteristics of the speakers (A.P.M. (Automatic Phase Matching))

You can set the A.P.M. (Automatic Phase Matching) function in the D.C.A.C. (Digital Cinema Auto Calibration). This calibrates the phase characteristics of the speakers for well-coordinated surround sound.

1. Select [Settings] - [Speaker Settings] from the home menu.
2. Select [Automatic Phase Matching].
3. Select the setting you want.
 - Auto: Switches the A.P.M. function on or off automatically.
 - Off

Note

- This function does not work in the following cases:
 - [2ch Analog Direct] is being used.
 - Headphones are connected.
 - [Auto Calibration] has not been performed.
- The receiver may play signals at a lower sampling frequency than the actual sampling frequency of the input signals, depending on the audio format.

Notes on use

4-488-938-11(1)

Copyright 2014 Sony Corporation



MULTI CHANNEL AV RECEIVER
STR-DN1050/STR-DN850

Selecting the speaker pattern and setting the assignment for the speaker terminals (Speaker Connection/SB Speaker Assign)

You can select the speaker pattern and set the assignment for the SPEAKERS SURROUND BACK/BI-AMP/FRONT HIGH/FRONT B terminals.

1. Select [Settings] - [Speaker Settings] from the home menu.
2. Select [Speaker Connection].
3. Select the speaker pattern you want.
4. Set [SB Speaker Assign] to any of the following settings (*).
 - Zone2 (for STR-DN1050 only)
When using the zone 2 connection.
 - Bi-Amp
When using the bi-amplifier connection.
 - Front B
When using the front B speaker connection.
 - Off
When none of the connections above are used.

* The displayed settings vary depending on the speaker pattern you selected in step 3.

Note

- You can only set [SB Speaker Assign] if the speaker pattern is set to a setting that does not have surround back and front high speakers.

Related Topic

[Connecting speakers](#)

Notes on use

4-488-938-11(1)

Copyright 2014 Sony Corporation



MULTI CHANNEL AV RECEIVER
STR-DN1050/STR-DN850

Adjusting the speaker level (Level/Distance/Size)

You can adjust the level of each speaker (front left/right, front high left/right, center, surround left/right, surround back left/right and subwoofer).

1. Select [Settings] - [Speaker Settings] from the home menu.
2. Select [Level/Distance/Size].
3. Select the speaker on the screen for which you want to adjust the speaker level.
4. Select [Level] and then press **↑** / **↓** to adjust the level.

Notes on use

4-488-938-11(1)

Copyright 2014 Sony Corporation



MULTI CHANNEL AV RECEIVER
STR-DN1050/STR-DN850

Adjusting the speaker distance (Level/Distance/Size)

You can adjust the distance from where you are sitting to each speaker (front left/right, front high left/right, center, surround left/right, surround back left/right, subwoofer).

1. Select [Settings] - [Speaker Settings] from the home menu.
2. Select [Level/Distance/Size].
3. Select the speaker on the screen for which you want to adjust the distance from where you are sitting.
4. Select [Distance] and then press **↑** / **↓** to adjust the distance.

Note

- Some parameters may not be available depending on the speaker pattern setting.

Hint

- When headphones are connected, [Distance] cannot be set.

Notes on use

4-488-938-11(1)

Copyright 2014 Sony Corporation



MULTI CHANNEL AV RECEIVER
STR-DN1050/STR-DN850

Adjusting the speaker size (Level/Distance/Size)

You can adjust the size of each speaker (front left/right, front high left/right, center, surround left/right, surround back left/right).

1. Select [Settings] - [Speaker Settings] from the home menu.
2. Select [Level/Distance/Size].
3. Select the speaker on the screen for which you want to adjust the size.
4. Select [Size], then press **↑** / **↓** to adjust the size.
 - Large: If you connect large speakers that will effectively reproduce bass frequencies, select [Large]. Select [Large] usually.
 - Small: If the sound is distorted, or you hear a lack of surround effects when using multi channel surround sound, select [Small]. You can activate the bass redirection circuitry and output the bass frequencies of each channel from the subwoofer or other [Large] speakers.

Hint

- The surround back speakers will be set to the same setting as that of the surround speakers.
- When the front speakers are set to [Small], the center, surround, and surround back/front high speakers are also automatically set to [Small].
- If you do not use the subwoofer, the front speakers are automatically set to [Large].
- [Size] cannot be set when headphones are connected.

Notes on use

4-488-938-11(1)

Copyright 2014 Sony Corporation



MULTI CHANNEL AV RECEIVER
STR-DN1050/STR-DN850

Setting the crossover frequency of the speakers (Crossover Frequency)

You can set the bass crossover frequency of speakers for which the speaker size has been set to [Small] in the Speaker Settings menu. A measured speaker crossover frequency is set for each speaker after the Auto Calibration is performed.

1. Select [Settings] - [Speaker Settings] from the home menu.
2. Select [Crossover Frequency].
3. Select the speaker for which you want to adjust the crossover frequency on the screen.
4. Press **↑** / **↓** to set the crossover frequency.

Note

- This function does not work when headphones are connected.
- The surround back speakers will be set to the same setting as that of the surround speakers.

Notes on use

4-488-938-11(1)

Copyright 2014 Sony Corporation



MULTI CHANNEL AV RECEIVER
STR-DN1050/STR-DN850

Outputting a test tone from each speaker (Test Tone)

You can output a test tone from each speaker in sequence.

1. Select [Settings] - [Speaker Settings] from the home menu.
2. Select [Test Tone].
3. Select the setting you want.
 - Off
 - Auto: The test tone is output from each speaker in sequence.
 - L, C, R, SR, SL, SB (*), SBL, SBR, FHL, FHR, SW: You can select which speakers will output the test tone.

* [SB] appears when only one surround back speaker is connected.

4. Adjust the speaker level.

Hint

- To adjust the level of all speakers at the same time, press \triangle +/- . You can also use MASTER VOLUME on the receiver.
- The adjusted value is shown on the TV screen during adjustment.

Notes on use

4-488-938-11(1)

Copyright 2014 Sony Corporation



MULTI CHANNEL AV RECEIVER
STR-DN1050/STR-DN850

Lifting up the sound of the center speaker (Center Speaker Lift Up)

By using the front high speakers, you can lift up the sounds of the center speaker to an appropriate height on the screen, allowing you to enjoy natural sound without discomfort.

1. Select [Settings] - [Speaker Settings] from the home menu.
2. Select [Center Speaker Lift Up].
3. Select the setting you want.
 - 1 - 10
 - Off

Hint

- This function does not work in the following cases:
 - Headphones are connected.
 - There is no center speaker.
 - There are no front high speakers.
 - The [2ch Stereo], [2ch Analog Direct], and [Multi Stereo] sound fields are being used.
 - A sound field for music is being used.

Notes on use

4-488-938-11(1)

Copyright 2014 Sony Corporation



MULTI CHANNEL AV RECEIVER
STR-DN1050/STR-DN850

Selecting the unit of measurement (Distance Unit)

You can select the unit of measurement for setting distances.

1. Select [Settings] - [Speaker Settings] from the home menu.
2. Select [Distance Unit].
3. Select the setting you want.
 - meter: The distance is displayed in meters.
 - feet: The distance is displayed in feet.

[Notes on use](#)

4-488-938-11(1)

Copyright 2014 Sony Corporation



MULTI CHANNEL AV RECEIVER
STR-DN1050/STR-DN850

Playing audio signals with high-quality sound (Digital Legato Linear (D.L.L.))

The D.L.L. function is Sony proprietary technology that allows low-quality digital and analog audio signals to be played with high-quality sound.

1. Select [Settings] - [Audio Settings] from the home menu.
2. Select [Digital Legato Linear].
3. Select the setting you want.
 - Auto 1: This function is available for lossy compression audio formats and analog audio signals.
 - Auto 2: This function is available for Linear PCM signals, as well as lossy compression audio formats and analog audio signals.
 - Off

Note

- This function may not work on some content via a USB device or home network.
- This function works when [2ch Stereo], [A.F.D. Auto], [Multi Stereo] or [Headphone (2ch)] is selected. However, this function does not work in the following cases:
 - [FM TUNER] or [AM TUNER] is selected as the input.
 - Linear PCM signals with a sampling frequency other than 44.1 kHz are being received.
 - Dolby Digital Plus, Dolby Digital EX, Dolby TrueHD, DTS 96/24, DTS-ES Matrix 6.1, DTS-HD Master Audio, or DTS-HD High Resolution Audio signals are being received.

Notes on use

4-488-938-11(1)

Copyright 2014 Sony Corporation



MULTI CHANNEL AV RECEIVER
STR-DN1050/STR-DN850

Setting the low-pass filter for the subwoofer output (Subwoofer Low Pass Filter)

You can turn the low-pass filter for the subwoofer output on or off. You can set the function for each input to which an audio input jack is assigned independently. Turn the function on if you connect a subwoofer without the crossover frequency function.

1. Select [Settings] - [Audio Settings] from the home menu.
2. Select [Subwoofer Low Pass Filter].
3. Select the setting you want.
 - On: Always activates the low-pass filter with a cutoff frequency of 120 Hz.
 - Off: Does not activate the low-pass filter.

Note

- This function does not work when [2ch Analog Direct] is being used.

Notes on use

4-488-938-11(1)

Copyright 2014 Sony Corporation



MULTI CHANNEL AV RECEIVER
STR-DN1050/STR-DN850

Synchronizing audio with video output (A/V Sync)

You can delay the output of audio to minimize the time gap between audio output and a visual display.

This function is useful when using a large LCD or plasma monitor or a projector. You can set the function for each input independently.

1. Select [Settings] - [Audio Settings] from the home menu.
2. Select [A/V Sync].
3. Select the setting you want.
 - HDMI Auto: The time gap between the audio output and visual display of a monitor connected via an HDMI connection will be adjusted automatically. This feature is available only when the monitor supports the A/V Sync function.
 - 0 ms – 300 ms: You can adjust the delay from 0 ms to 300 ms in 10 ms intervals.

Note

- The receiver may play signals at a lower sampling frequency than the actual sampling frequency of the input signals, depending on the audio format.

[Notes on use](#)

4-488-938-11(1)

Copyright 2014 Sony Corporation



MULTI CHANNEL AV RECEIVER
STR-DN1050/STR-DN850

Adjusting the volume automatically (Advanced Auto Volume)

This receiver can adjust its volume automatically depending on the input signal or content from a connected device. This function is useful, for example, when the sound of commercials is louder than a TV program.

1. Select [Settings] - [Audio Settings] from the home menu.
2. Select [Advanced Auto Volume].
3. Set to [On] or [Off].

Note

- Be sure to reduce the volume level before you turn this function on or off.
- The Advanced Auto Volume function may not work, depending on the audio format.
- This function does not work when [2ch Analog Direct] is being used.

Notes on use

4-488-938-11(1)

Copyright 2014 Sony Corporation



MULTI CHANNEL AV RECEIVER
STR-DN1050/STR-DN850

Selecting the language of digital broadcasts (Dual Mono)

You can select the language you want when listening to a digital broadcast with dual audio. This function only works for Dolby Digital sources.

1. Select [Settings] - [Audio Settings] from the home menu.
2. Select [Dual Mono].
3. Select the setting you want.
 - Main: Sound in the main language will be output.
 - Sub: Sound in the sub language will be output.
 - Main/Sub: Sound in the main language will be output through the front left speaker and sound in the sub language will be output through the front right speaker simultaneously.

[Notes on use](#)

4-488-938-11(1)

Copyright 2014 Sony Corporation



MULTI CHANNEL AV RECEIVER
STR-DN1050/STR-DN850

Compressing the dynamic range (Dynamic Range Compressor)

You can compress the dynamic range of the soundtrack. This may be useful when you want to watch movies at a low volume late at night, etc.

This function only works for Dolby Digital and Dolby TrueHD sources.

1. Select [Settings] - [Audio Settings] from the home menu.
2. Select [Dynamic Range Compressor].
3. Select the setting you want.
 - Auto: The dynamic range is compressed automatically when there is a flag in the sound source that recommends using the Dynamic Range Compressor function.
 - On: The dynamic range is compressed as intended by the recording engineer.
 - Off

[Notes on use](#)

4-488-938-11(1)

Copyright 2014 Sony Corporation



MULTI CHANNEL AV RECEIVER
STR-DN1050/STR-DN850

Up-converting video signals to 4K (4K Scaling)

You can up-convert video signals to 4K and output them through the HDMI OUT jacks of the receiver.

1. Select [Settings] - [HDMI Settings] from the home menu.
2. Select [4K Scaling].
3. Select the setting you want.
 - Auto: Enables video scaling control of 4K HDMI output automatically if you connect a 4K-compatible TV.
 - Off

Note

- This function works only when video signals from the VIDEO IN, COMPONENT VIDEO IN (for STR-DN1050 only), or HDMI IN jacks are being received. HDMI video input signals must be 1080p/24 Hz.

Notes on use

4-488-938-11(1)

Copyright 2014 Sony Corporation



MULTI CHANNEL AV RECEIVER
STR-DN1050/STR-DN850

Controlling HDMI devices (Control for HDMI)

You can turn the Control for HDMI function on or off. For details, see [“Preparing for “BRAVIA” Sync.”](#)

1. Select [Settings] - [HDMI Settings] from the home menu.
2. Select [Control for HDMI].
3. Set to [On] or [Off].

Note

- When you set [Control for HDMI] to [On], [Audio Out] may be changed automatically.
- When the receiver is in standby mode, the ν/ψ (on/standby) indicator on the front panel lights up in amber if [Control for HDMI] is set to [On].

Related Topic

● [Preparing for “BRAVIA” Sync](#)

Notes on use

4-488-938-11(1)

Copyright 2014 Sony Corporation



MULTI CHANNEL AV RECEIVER
STR-DN1050/STR-DN850

Passing HDMI signals through (Pass Through)

You can output HDMI signals to the TV even when the receiver is in standby mode.

1. Select [Settings] - [HDMI Settings] from the home menu.
2. Select [Pass Through].
3. Select the setting you want.
 - Auto: The receiver outputs HDMI signals to the TV from the HDMI OUT jack when the TV is turned on while the receiver is in the standby mode.
Sony recommends this setting if you are using a “BRAVIA” Sync-compatible Sony TV. This setting saves power in the standby mode compared to the [On] setting.
 - On (*): The receiver continuously outputs HDMI signals from the HDMI OUT jack when in standby mode.
 - Off: The receiver does not output HDMI signals when in standby mode.
This setting saves power in the standby mode compared to the [On] setting.

* For USA, Canadian, Mexican, and Australian models only

Note

- When the receiver is in standby mode, the I/O (on/standby) indicator on the front panel lights up in amber if [Pass Through] is set to [On] (*) or [Auto].
- When [Auto] is selected, it may take a little more time for the image and sound to be output to the TV than when [On] is selected (*).

* For USA, Canadian, Mexican, and Australian models only

Notes on use

4-488-938-11(1)

Copyright 2014 Sony Corporation



MULTI CHANNEL AV RECEIVER
STR-DN1050/STR-DN850

Setting the HDMI audio signal output of connected devices (Audio Out)

You can set the HDMI audio signal output of playback devices connected to the receiver via an HDMI connection.

1. Select [Settings] - [HDMI Settings] from the home menu.
2. Select [Audio Out].
3. Select the setting you want.
 - AMP: HDMI audio signals from playback devices are only output to the speakers connected to the receiver. Multi-channel sound can be played back as it is.
 - TV+AMP: The sound is output from the speaker of the TV and the speakers connected to the receiver.

Note

- Audio signals are not output from the speaker of the TV when [Audio Out] is set to [AMP].
- The sound quality of the playback equipment depends on the sound quality of the TV, such as the number of channels and the sampling frequency, etc. If the TV has stereo speakers, the sound output from the receiver is in the same stereo as the TV, even when playing back multi-channel source.
- When you connect the receiver to a video device (projector, etc.), sound may not be output from the receiver. In this case, select [AMP].

[Notes on use](#)

4-488-938-11(1)

Copyright 2014 Sony Corporation



MULTI CHANNEL AV RECEIVER
STR-DN1050/STR-DN850

Setting the level of the subwoofer (Subwoofer Level)

You can set the level of the subwoofer to 0 dB or +10 dB when PCM signals are input via an HDMI connection. The level for each input to which an HDMI input jack is assigned can be set independently.

1. Select [Settings] - [HDMI Settings] from the home menu.
2. Select [Subwoofer Level].
3. Select the setting you want.
 - Auto: Automatically sets the level to 0 dB or +10 dB, depending on the audio stream.
 - +10 dB
 - 0 dB

Note

- This setting is invalid when [FM TUNER], [AM TUNER], [USB], [Bluetooth], [Home Network], or [Music Services] is selected.

Notes on use

4-488-938-11(1)

Copyright 2014 Sony Corporation



MULTI CHANNEL AV RECEIVER
STR-DN1050/STR-DN850

Speeding up the display when switching the HDMI input (Fast View)

You can set the Fast View function for the HDMI inputs.

1. Select [Settings] - [HDMI Settings] from the home menu.
2. Select [Fast View].
3. Select the setting you want.
 - Auto: You can select HDMI input faster than normal selection.
 - Off: The Fast View function is not available.

[Notes on use](#)

4-488-938-11(1)

Copyright 2014 Sony Corporation



MULTI CHANNEL AV RECEIVER
STR-DN1050/STR-DN850

Automatically switching the input when an MHL device is played (MHL Auto Input)

This allows you to turn the function that automatically switches input to the MHL device input on or off when the MHL device is played.

1. Select [Settings] - [HDMI Settings] from the home menu.
2. Select [MHL Auto Input].
3. Select [On] or [Off].

[Notes on use](#)

4-488-938-11(1)

Copyright 2014 Sony Corporation



MULTI CHANNEL AV RECEIVER
STR-DN1050/STR-DN850

Changing the assignment and display for the input jacks

You can customize the settings for each input according to your preferences and usage. Select [Settings] - [Input Settings] from the home menu, then set each item shown below.

Input

You can change the settings of [Icon], [Name], [Watch/Listen], [COMPONENT] (*) and [OPT/COAX] for each input.

* For STR-DN1050 only

Note

- The settings of [HDMI], [COMPOSITE], and [AUDIO] on the Input Settings screen are fixed and cannot be changed.

Icon

You can set the icon displayed on the Watch/Listen menu.

Name

You can change the name displayed on the Watch/Listen menu. For details on how to set the name for each input, see [“Changing the name for each input \(Name\).”](#)

Watch/Listen

You can set whether an input is displayed on the Watch menu or the Listen menu.

- W: Displays an input to the Watch menu.
- L: Displays an input to the Listen menu.
- W/L: Displays an input to both the Watch and Listen menus.

COMPONENT (for STR-DN1050 only)

You can set the video input jack(s) assigned to each input. For details, see [“Using other video/audio input jacks \(Input Assign\).”](#)

- IN 2
- IN 1
- None

OPT/COAX

You can set the digital audio input jack(s) assigned to each input. For details, see [“Using other video/audio input jacks \(Input Assign\).”](#)

- OPT 2
- OPT 1
- COAX
- None



MULTI CHANNEL AV RECEIVER
STR-DN1050/STR-DN850

Changing the name for each input (Name)

You can enter up to 8 characters for each input name.

1. Select [Settings] - [Input Settings] from the home menu.
2. Select the input name you want to change.
3. Select [Name].
An on-screen keyboard appears on the TV screen.
4. Press **↑** / **↓** / **←** / **→** and **+** to select characters one by one to enter the name.
5. Select [Enter].
The name you entered is registered.

Notes on use

4-488-938-11(1)

Copyright 2014 Sony Corporation



MULTI CHANNEL AV RECEIVER
STR-DN1050/STR-DN850

Turning on/off the Wi-Fi function (Wi-Fi)

1. Select [Settings] - [Network Settings] from the home menu.
2. Select [Wi-Fi].
3. Set to [On] or [Off].

Note

- You cannot change this setting when a LAN cable is connected to the receiver.

[Notes on use](#)

4-488-938-11(1)

Copyright 2014 Sony Corporation



MULTI CHANNEL AV RECEIVER
STR-DN1050/STR-DN850

Setting up a network (Internet Setting)

You can set up a network connection. For details on Internet Setting, see “[Setting up a wired LAN connection](#)” or “[Selecting a wireless LAN connection method.](#)”

[Notes on use](#)

4-488-938-11(1)

Copyright 2014 Sony Corporation



MULTI CHANNEL AV RECEIVER
STR-DN1050/STR-DN850

Checking the network information (Information)

1. Select [Settings] - [Network Settings] from the home menu.
2. Select [Information].
You can check the settings (*) for [Connection Type], [Connection Status], [IP Address Setting], [IP Address], [SSID], [Security Type], [Subnet Mask], [Default Gateway], [DNS Settings], [Primary DNS], [Secondary DNS], and [MAC Address].

* The setting items during setup differ depending on the network environment and connection type.

[Notes on use](#)

4-488-938-11(1)

Copyright 2014 Sony Corporation



MULTI CHANNEL AV RECEIVER
STR-DN1050/STR-DN850

Assigning a name to the receiver (Device Name)

You can assign a device name to the receiver to make it easily recognizable by other devices on the home network.

1. Select [Settings] - [Network Settings] from the home menu.
2. Select [Device Name].
An on-screen keyboard appears on the TV screen.
3. Press **↑** / **↓** / **←** / **→** and **+** to select characters one by one to enter the name.
4. Select [Enter].
The name you entered is registered.

[Notes on use](#)

4-488-938-11(1)

Copyright 2014 Sony Corporation



MULTI CHANNEL AV RECEIVER
STR-DN1050/STR-DN850

Turning on the control mode for maintenance (External Control)

You can set whether a dedicated controller such as “SongPal” on the home network is allowed to control the receiver.

1. Select [Settings] - [Network Settings] from the home menu.
2. Select [External Control].
3. Set to [On] or [Off].

Related Topic

- [Setting control permissions to all devices on the home network \(DLNA Control Permission\)](#)
- [Setting whether to control this receiver from a device on the home network \(DLNA Control Permission\)](#)
- [Controlling the receiver using a smartphone or tablet device \(SongPal\)](#)

Notes on use

4-488-938-11(1)

Copyright 2014 Sony Corporation



MULTI CHANNEL AV RECEIVER
STR-DN1050/STR-DN850

Enabling the network function even when this receiver is in standby mode (Network Standby) (for USA and Canadian models only)

1. Select [Settings] - [Network Settings] from the home menu.
2. Select [Network Standby].
3. Set to [On] or [Off].
 - On : The network function works even when the receiver is in standby mode, and the receiver resumes operation when controlled over the network.
 - Off : The network function turns off when the receiver is in standby mode. The receiver takes more time to resumes operation when powered on again.

Note

- When the receiver is in standby mode, the  (on/standby) indicator on the front panel lights up in amber if [Network Standby] is set to [On].

[Notes on use](#)

4-488-938-11(1)

Copyright 2014 Sony Corporation



MULTI CHANNEL AV RECEIVER
STR-DN1050/STR-DN850

Checking registered TV SideView devices (TV SideView Setup)

You can check the TV SideView devices that are allowed to control the receiver.

1. Select [Settings] - [Network Settings] from the home menu.
2. Select [TV SideView Setup].

Related Topic

- [Setting control permissions to all devices on the home network \(DLNA Control Permission\)](#)
- [Setting whether to control this receiver from a device on the home network \(DLNA Control Permission\)](#)
- [Registering a TV SideView device to the receiver](#)

Notes on use

4-488-938-11(1)

Copyright 2014 Sony Corporation



MULTI CHANNEL AV RECEIVER
STR-DN1050/STR-DN850

Bluetooth Pairing

You can activate the pairing mode of the receiver.

1. Select [Settings] - [Bluetooth Settings] from the home menu.

2. Select [Bluetooth Pairing].

For details on subsequent procedures, see step 4 onwards in [“Enjoying audio content stored on a BLUETOOTH device.”](#)

Notes on use

4-488-938-11(1)

Copyright 2014 Sony Corporation



MULTI CHANNEL AV RECEIVER
STR-DN1050/STR-DN850

Setting the Bluetooth Standby mode (Bluetooth Standby)

You can set the Bluetooth Standby mode so that the receiver can be controlled by a BLUETOOTH device even when the receiver is in standby mode.

1. Press BLUETOOTH on the receiver.

You can also select [Listen] - [Bluetooth] from the home menu.

2. Press OPTIONS.

The options menu appears.

3. Select [Bluetooth Standby].

4. Select [Yes].

The receiver turns on automatically when you establish a BLUETOOTH connection from a BLUETOOTH device.

Select [No] to turn off this function.

Note

- When the receiver is in standby mode, the \mathcal{I}/\mathcal{O} (on/standby) indicator on the front panel lights up in amber if [Bluetooth Standby] is set to [Yes].
- You can only select this parameter when a BLUETOOTH device is paired.

Hint

- You can select [Bluetooth Standby] in [Settings] - [Bluetooth Settings] from the home menu.

Notes on use

4-488-938-11(1)

Copyright 2014 Sony Corporation



MULTI CHANNEL AV RECEIVER
STR-DN1050/STR-DN850

Setting BLUETOOTH audio codecs (Bluetooth AAC/Bluetooth aptX)

You can enable and disable AAC (Advanced Audio Coding) or aptX audio.

1. Press BLUETOOTH on the receiver.
You can also select [Listen] - [Bluetooth] from the home menu.
2. Press OPTIONS.
The option menu appears.
3. Select [Bluetooth AAC] or [Bluetooth aptX].
4. Select [On] or [Off].
 - On: AAC and/or aptX audio is available.
 - Off: AAC and/or aptX audio is not available.

Note

- You can enjoy high-quality sound if AAC or aptX is enabled.
- When you change this setting, the BLUETOOTH device is disconnected from the receiver automatically.

Hint

- You can select [Bluetooth AAC] or [Bluetooth aptX] in [Settings] - [Bluetooth Settings] from the home menu.

Notes on use

4-488-938-11(1)

Copyright 2014 Sony Corporation



MULTI CHANNEL AV RECEIVER
STR-DN1050/STR-DN850

Turning on/off the power for zone 2 (Power) (for STR-DN1050 only)

You can turn on or off the power for zone 2 by the following procedure.

1. Select [Settings] - [Zone Settings] from the home menu.
2. Select [Power].
3. Select [On] or [Off].

Note

- The receiver in zone 2 remains turned on even when this receiver is in standby mode (press \mathcal{I}/\mathcal{O} (on/standby) on the remote control to turn off this receiver).
- When the receiver is in standby mode, the \mathcal{I}/\mathcal{O} (on/standby) indicator on the front panel lights up in amber if the receiver in zone 2 is turned on.
- AirPlay function is available in main zone only.

Hint

- You can also turn on or off the power for zone 2 using ZONE POWER on the receiver.

Notes on use

4-488-938-11(1)

Copyright 2014 Sony Corporation



MULTI CHANNEL AV RECEIVER
STR-DN1050/STR-DN850

Selecting the source signals for zone 2 (Input) (for STR-DN1050 only)

You can select the source signals for zone 2 using the following procedure.

1. Select [Settings] - [Zone Settings] from the home menu.
2. Select [Input].
3. Select the source signals you want to output.

Hint

- You can also select the source signals for zone 2 using ZONE CONTROL and INPUT SELECTOR on the receiver while [2. xxxx (input name)] is shown on the display panel.

[Notes on use](#)

4-488-938-11(1)

Copyright 2014 Sony Corporation



MULTI CHANNEL AV RECEIVER
STR-DN1050/STR-DN850

Adjusting the volume for zone 2 (Volume) (for STR-DN1050 only)

You can adjust the volume for zone 2 using the following procedure in the following cases:

- When using the connections described in [“Connecting the speakers in zone 2 \(for STR-DN1050 only\).”](#)
 - When using the connections described in [“Connecting another amplifier in zone 2 \(for STR-DN1050 only\),”](#) and when [Lineout] for zone 2 is set to [Variable].
1. Select [Settings] - [Zone Settings] from the home menu.
 2. Select [Volume].
 3. Select the volume level.

Note

- If [Lineout] for zone 2 is set to [Fixed], adjust the volume using the receiver in zone 2.

Hint

- You can also adjust the volume using ZONE CONTROL and MASTER VOLUME on the receiver while [2. xxxx (input name)] is shown on the display panel.

Notes on use

4-488-938-11(1)

Copyright 2014 Sony Corporation



MULTI CHANNEL AV RECEIVER
STR-DN1050/STR-DN850

Selecting the language (Language)

You can select the language of messages on the screen.

1. Select [Settings] - [System Settings] from the home menu.
2. Select [Language].
3. Select the language you want.

[Notes on use](#)

4-488-938-11(1)

Copyright 2014 Sony Corporation



MULTI CHANNEL AV RECEIVER
STR-DN1050/STR-DN850

Tuning on/off the display for the volume level or sound field (Auto Display)

This function allows you to turn the information display which appears on the TV screen on or off when the volume level or sound field, etc. of the receiver is changed.

1. Select [Settings] - [System Settings] from the home menu.
2. Select [Auto Display].
3. Select [On] or [Off].

[Notes on use](#)

4-488-938-11(1)

Copyright 2014 Sony Corporation



MULTI CHANNEL AV RECEIVER
STR-DN1050/STR-DN850

Setting standby mode (Auto Standby)

You can set the receiver to switch to standby mode automatically when you do not operate the receiver or when no signals are input to the receiver.

1. Select [Settings] - [System Settings] from the home menu.
2. Select [Auto Standby].
3. Set [On] or [Off].

When you set [On], the receiver switches to standby mode after approximately 20 minutes.

Note

- This function does not work in the following cases:
 - [FM TUNER] or [AM TUNER] is selected as the input.
 - The software of the receiver is being updated.
- If you use the Auto Standby mode and the sleep timer at the same time, the sleep timer has priority.

Notes on use

4-488-938-11(1)

Copyright 2014 Sony Corporation



MULTI CHANNEL AV RECEIVER
STR-DN1050/STR-DN850

Receiving information on newer software (Software Update Notification)

You can set whether or not to be informed of newer software version information on the TV screen.

1. Select [Settings] - [System Settings] from the home menu.
2. Select [Software Update Notification].
3. Set to [On] or [Off].

Note

- New software version information does not appear in the following cases:
 - The latest version is already being used.
 - The receiver cannot obtain data via a network.

[Notes on use](#)

4-488-938-11(1)

Copyright 2014 Sony Corporation



MULTI CHANNEL AV RECEIVER
STR-DN1050/STR-DN850

Checking the software version (Software Version)

You can check the current software version of the receiver.

1. Select [Settings] - [System Settings] from the home menu.
2. Check [Software Version].

[Notes on use](#)

4-488-938-11(1)

Copyright 2014 Sony Corporation



MULTI CHANNEL AV RECEIVER
STR-DN1050/STR-DN850

Updating the software (Network Update)

By downloading the latest version of the software, you can take advantage of the newest functions.
For details on available software updates, refer to the customer support site.

1. Select [Settings] - [System Settings] from the home menu.
2. Select [Network Update].
3. Select [Start].

The time required for the downloading process varies depending on the download conditions, such as the speed of the Internet connection, etc.

[Downloading 100%] appears on the TV screen when the download is completed.

When the download is completed, the receiver automatically starts to update the software. During the software updates, the displays on the TV screen and display panel are turned off automatically. Only the \mathcal{I}/\mathcal{O} (on/standby) indicator on the front panel flashes slowly.

The update process may take about 40 minutes at the longest to complete.

When the update is completed, [COMPLETE] appears on the display panel and the receiver will restart automatically.

Note

- Make sure not to turn off the receiver, disconnect the network cable or perform any operations on the receiver while the update is in progress.
- Once you start the update, you cannot restore the previous software version.
- If you try to update the software when the sleep timer is on, the sleep timer will turn off automatically.

[Notes on use](#)

4-488-938-11(1)

Copyright 2014 Sony Corporation



MULTI CHANNEL AV RECEIVER
STR-DN1050/STR-DN850

Operating the receiver with the menu on the display panel

You can operate this receiver using the display panel even if the TV is not connected to the receiver.

1. Press AMP MENU.
The menu is displayed on the display panel of the receiver.
2. Press **↑** / **↓** repeatedly to select the menu you want, then press **+**.
3. Press **↑** / **↓** repeatedly to select the parameter you want to adjust, then press **+**.
4. Press **↑** / **↓** repeatedly to select the setting you want, then press **+**.

To return to the previous display

Press **←** or RETURN.

To exit the menu

Press AMP MENU.

Note

- Some parameters and settings may appear dimmed on the display panel. This means that they are either unavailable or fixed and unchangeable.

Related Topic

[Menu list \(on the display panel\)](#)

Notes on use

4-488-938-11(1)

Copyright 2014 Sony Corporation



MULTI CHANNEL AV RECEIVER
STR-DN1050/STR-DN850

Reverting to the factory default settings

You can clear all memorized settings and restore the receiver to the factory default settings by the following procedure. This procedure can also be used to initialize the receiver before you use it for the first time. Be sure to use the buttons on the receiver to perform this operation.

1. Turn off the receiver.
2. Hold down I/O (on/standby) on the receiver for 5 seconds.
[CLEARING] appears on the display panel for a while, then changes to [CLEARED!].

Note

- It takes a few minutes for the memory to be cleared completely. Do not turn the receiver off until [CLEARED!] appears on the display panel.

Notes on use

4-488-938-11(1)

Copyright 2014 Sony Corporation

MULTI CHANNEL AV RECEIVER
STR-DN1050/STR-DN850

Front panel (STR-DN1050)

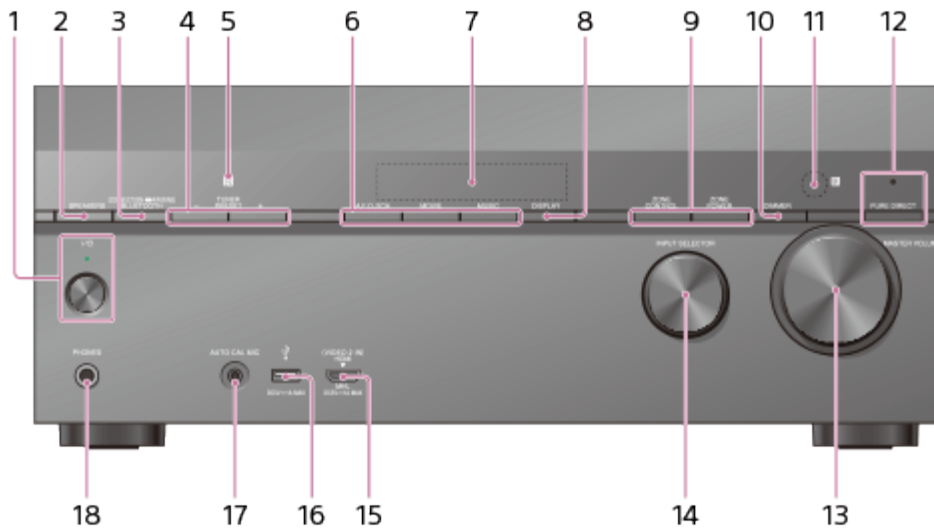

1. I/O (on/standby)
2. SPEAKERS
3. CONNECTION PAIRING BLUETOOTH
Operates the BLUETOOTH function.
4. TUNER PRESET +/-
5. NFC sensor
6. A.F.D./2CH, MOVIE, MUSIC
7. Display panel
8. DISPLAY
9. ZONE CONTROL, ZONE POWER
10. DIMMER
Adjusts the brightness of the display panel in 3 levels.
11. Remote control sensor
Receives signals from remote control.
12. PURE DIRECT
The indicator above the button lights up when the Pure Direct function is activated.
13. MASTER VOLUME
14. INPUT SELECTOR
15. HDMI/MHL (VIDEO 2 IN) jack
16. ψ (USB) port
17. AUTO CAL MIC jack

18. PHONES jack

Connect headphones here.

Indicator light above  (on/standby) button (1)

- Green: The receiver is turned on.
- Amber: The receiver is in standby mode, and:
 - [Control for HDMI], [Network Standby] (*1), or [Bluetooth Standby] is set to [On].
 - [Pass Through] is set to [On] (*2) or [Auto].
 - The receiver in zone 2 is turned on.

Indicator turns off when the receiver is in standby mode and [Control for HDMI], [Pass Through], [Network Standby] (*1), and [Bluetooth Standby] are set to [Off], and the receiver in zone 2 is turned off.

*1 For USA and Canadian models only

*2 For USA, Canadian, Mexican, and Australian models only

Note

- The indicator flashes slowly when a software update is in progress.

Notes on use

4-488-938-11(1)

Copyright 2014 Sony Corporation

MULTI CHANNEL AV RECEIVER
STR-DN1050/STR-DN850

Front panel (STR-DN850)

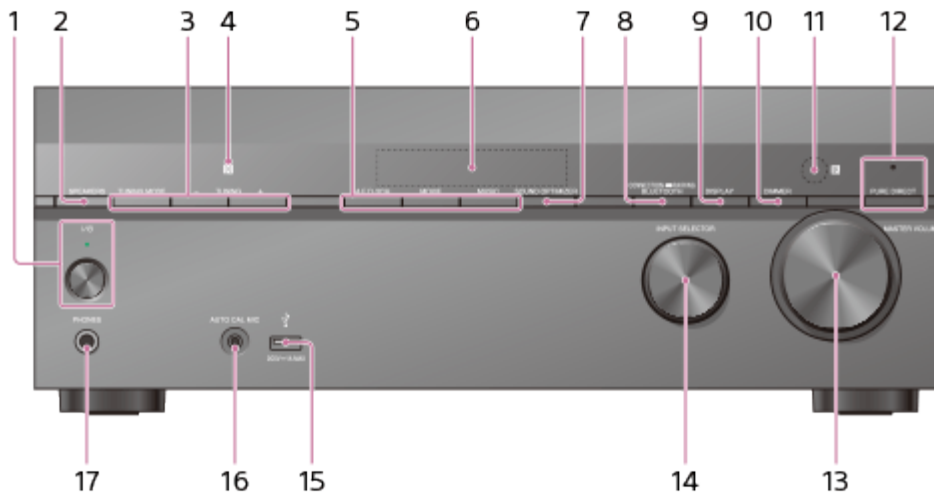

1. \mathcal{P} (on/standby)
2. SPEAKERS
3. TUNING MODE, TUNING +/-
Press TUNING MODE to operate a tuner (FM/AM).
Press TUNING +/- to scan a station.
4. NFC sensor
5. A.F.D./2CH, MOVIE, MUSIC
6. Display panel
7. SOUND OPTIMIZER
8. CONNECTION PAIRING BLUETOOTH
Operates the BLUETOOTH function.
9. DISPLAY
10. DIMMER
Adjusts the brightness of the display panel in 3 levels.
11. Remote control sensor
Receives signals from remote control.
12. PURE DIRECT
The indicator above the button lights up when the Pure Direct function is activated.
13. MASTER VOLUME
14. INPUT SELECTOR
15. ψ (USB) port
16. AUTO CAL MIC jack

17. PHONES jack

Connect headphones here.

Indicator light above  (on/standby) button (1)

- Green: The receiver is turned on.
- Amber: The receiver is in standby mode, and:
 - [Control for HDMI], [Network Standby] (*1), or [Bluetooth Standby] is set to [On].
 - [Pass Through] is set to [On] (*2) or [Auto].

Indicator turns off when the receiver is in standby mode and [Control for HDMI], [Pass Through], [Network Standby] (*1), and [Bluetooth Standby] are set to [Off].

*1 For USA and Canadian models only

*2 For USA, Canadian, and Australian models only

Note

- The indicator flashes slowly when a software update is in progress.

Notes on use

4-488-938-11(1)

Copyright 2014 Sony Corporation

MULTI CHANNEL AV RECEIVER
STR-DN1050/STR-DN850

Rear panel (STR-DN1050)

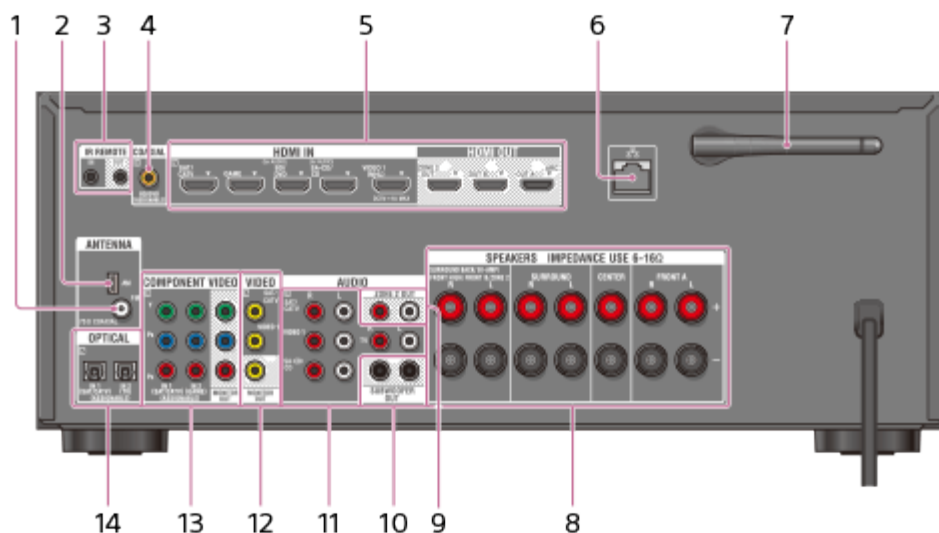

1. FM ANTENNA terminal
2. AM ANTENNA terminal
3. IR REMOTE IN/OUT jacks
 - You can control the receiver from a distance by connecting an IR repeater (not supplied) to the IR REMOTE IN jack.
 - You can start or stop playback of devices such as a CD player connected to the receiver by connecting an IR Blaster (not supplied) to the IR REMOTE OUT jack.
4. COAXIAL IN jack
5. HDMI IN/OUT (*1) jacks
6. LAN port (*2)
7. Wireless LAN antenna
8. SPEAKERS terminals
9. ZONE 2 OUT jacks
10. SUBWOOFER OUT jacks
11. AUDIO IN jacks
12. VIDEO IN/OUT (*1) jacks
13. COMPONENT VIDEO IN/OUT (*1) jacks
14. OPTICAL IN jacks

*1 You must connect your TV to HDMI OUT or MONITOR OUT to watch images from the selected input.

*2 You can also use this port for maintenance and service.

MULTI CHANNEL AV RECEIVER
STR-DN1050/STR-DN850

Rear panel (STR-DN850)

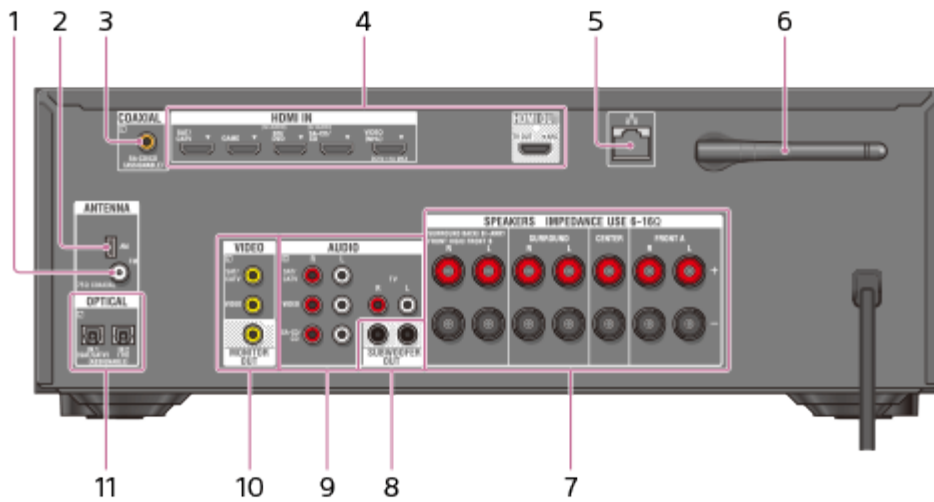

1. FM ANTENNA terminal
2. AM ANTENNA terminal
3. COAXIAL IN jack
4. HDMI IN/OUT (*1) jacks
5. LAN port (*2)
6. Wireless LAN antenna
7. SPEAKERS terminals
8. SUBWOOFER OUT jacks
9. AUDIO IN jacks
10. VIDEO IN/OUT (*3) jacks
11. OPTICAL IN jacks

*1 You must connect your TV to HDMI OUT to watch images from the selected input.

*2 You can also use this port for maintenance and service.

*3 You must connect your TV to MONITOR OUT to watch images from the selected input.

[Notes on use](#)

4-488-938-11(1)

Copyright 2014 Sony Corporation

MULTI CHANNEL AV RECEIVER
STR-DN1050/STR-DN850

Indicators on the display panel

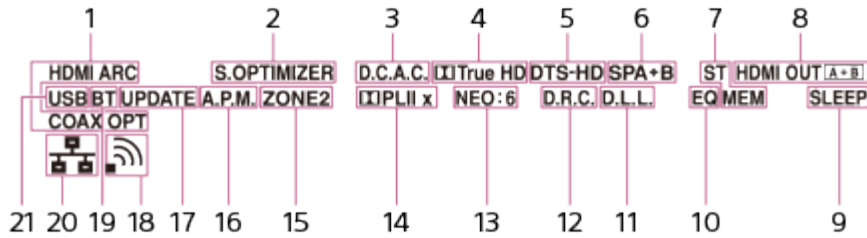

1. Input indicator

Lights up to indicate the current input.

HDMI

The receiver recognizes devices connected via an HDMI IN jack.

ARC

TV input is selected and Audio Return Channel (ARC) signals are detected.

COAX

Digital signals are input through the COAXIAL jack.

OPT

Digital signals are input through the OPTICAL jack.

2. S.OPTIMIZER

Lights up when the Sound Optimizer function is activated.

3. D.C.A.C.

Lights up when the measurement results of the Auto Calibration function are applied.

4. Dolby Digital Surround indicator

The applicable indicator lights up when the receiver is decoding the corresponding Dolby Digital format signals.

: Dolby Digital

 TrueHD: Dolby TrueHD

5. DTS(-HD) indicator

The applicable indicator lights up when the receiver is decoding the corresponding DTS format signals.

DTS: DTS

DTS-HD: DTS-HD

6. Speaker system indicator







7. Tuning indicator

ST

Lights up when the receiver tunes to a stereo broadcast.

8. HDMI OUT A + B (for STR-DN1050 only)

9. SLEEP

- Lights up when the sleep timer is activated.
- 10. EQ
Lights up when the equalizer is activated.
- 11. D.L.L.
Lights up when the Digital Legato Linear (D.L.L.) function is activated.
- 12. D.R.C.
Lights up when dynamic range compression is activated.
- 13. NEO:6
Lights up when DTS Neo:6 Cinema/Music decoding is activated.
- 14. Dolby Pro Logic indicator
The applicable indicator lights up when the receiver performs Dolby Pro Logic processing. This matrix surround decoding technology can enhance input signals.
 -  PL: Dolby Pro Logic
 -  PLII: Dolby Pro Logic II
 -  PLIIx: Dolby Pro Logic IIx
- 15. ZONE2 (for STR-DN1050 only)
Lights up while the power for zone 2 is turned on.
- 16. A.P.M.
Lights up when the A.P.M. (Automatic Phase Matching) function is activated. You can only set the A.P.M. function in the D.C.A.C. (Digital Cinema Auto Calibration) function.
- 17. UPDATE
Lights up when new software is available.
- 18. Wireless LAN signal strength indicator
Lights up to show the strength of the wireless LAN signal.
 -  : No signal.
 -  : Weak signal.
 -  : Moderate signal.
 -  : Strong signal.
- 19. BT
Lights up when a BLUETOOTH device is connected. Flashes during pairing.
- 20. Wired LAN indicator
Lights up when a LAN cable is connected.
- 21. USB
Lights up when an iPhone/iPod or USB device is detected.

Notes on use

4-488-938-11(1)

Copyright 2014 Sony Corporation

MULTI CHANNEL AV RECEIVER
STR-DN1050/STR-DN850

Remote control

Use the supplied remote control to operate this receiver.

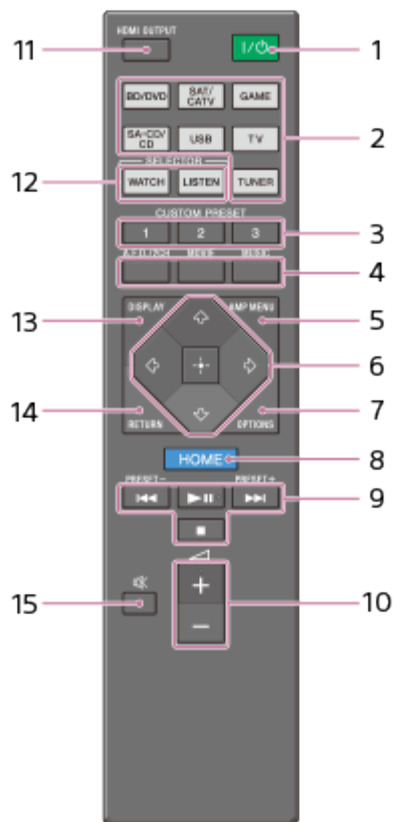

1. I/O (on/standby)

Turns the receiver on or sets it to the standby mode.

Saving power in standby mode

Save power by setting the receiver as follows:

- Set [Control for HDMI], [Pass Through], [Network Standby] (for USA and Canadian models only), and [Bluetooth Standby] to [Off].
- Turn off the receiver in zone 2 (for STR-DN1050 only).

2. Input buttons











Select the device you want to use.

When you press any of the input buttons, the receiver turns on.

3. CUSTOM PRESET

4. A.F.D./2CH, MOVIE, MUSIC

Select a sound field.

5. AMP MENU
Displays the menu to operate the receiver.
6. ,  /  /  / 
7. OPTIONS
Display and select items from the options menus.
8. HOME
Displays the menu of the audio/video device that is currently being controlled by the remote control.
9.  / ,  (*), 
Skip, play, pause, stop operation.
PRESET +/-
Select preset stations or channels.
10.  + (*)/-
Adjust the volume level of all speakers at the same time.
11. HDMI OUTPUT
Switches the output for two monitors connected to the HDMI OUT A and HDMI OUT B jacks (for STR-DN1050 only).
Turns the output for HDMI TV OUT on/off (for STR-DN850 only).
12. WATCH, LISTEN Select [Watch] or [Listen] on the home menu directly. When pressing these buttons on the Watch or Listen screen, you can move the focus to select the desired input.
13. DISPLAY
View information on the display panel.
14. RETURN
Returns to the previous menu or exits a menu or on-screen guide that is displayed on the TV screen.
15. 
Turns off the sound temporarily. Press the button again to restore the sound.

* The  and + buttons have tactile dots. Use the tactile dots as a reference when operating the receiver.

Note

- The above explanations are intended to serve as examples.
- Depending on the model of your connected device, some functions explained in this section may not work with the supplied remote control.

Notes on use

4-488-938-11(1)

Copyright 2014 Sony Corporation

MULTI CHANNEL AV RECEIVER
STR-DN1050/STR-DN850

Specifications

POWER OUTPUT AND TOTAL HARMONIC DISTORTION: (USA model only)

STR-DN1050:

With 6 ohm loads, both channels driven, from 20 – 20,000 Hz; rated 100 watts per channel minimum RMS power, with no more than 0.09% total harmonic distortion from 250 milliwatts to rated output.

STR-DN850:

With 6 ohm loads, both channels driven, from 20 – 20,000 Hz; rated 95 watts per channel minimum RMS power, with no more than 0.09% total harmonic distortion from 250 milliwatts to rated output.

Amplifier section

Mexican model

STR-DN1050:

Minimum RMS Output Power (*1): 95 W + 95 W (6 ohms, 20 Hz – 20 kHz, THD 0.09%)

Stereo Mode Output Power (*1): 110 W + 110 W (6 ohms, 1 kHz, THD 1%)

Surround Mode Output Power (*1)(*2): 145 W per channel (6 ohms, 1 kHz, THD 0.9%)

Other models

STR-DN1050:

Minimum RMS Output Power (*1): 100 W + 100 W (6 ohms, 20 Hz – 20 kHz, THD 0.09%)

Stereo Mode Output Power (*1): 120 W + 120 W (6 ohms, 1 kHz, THD 1%)

Surround Mode Output Power (*1)(*2): 165 W per channel (6 ohms, 1 kHz, THD 0.9%)

STR-DN850:

Minimum RMS Output Power (*1): 95 W + 95 W (6 ohms, 20 Hz – 20 kHz, THD 0.09%)

Stereo Mode Output Power (*1): 110 W + 110 W (6 ohms, 1 kHz, THD 1%)

Surround Mode Output Power (*1)(*2): 150 W per channel (6 ohms, 1 kHz, THD 0.9%)

*1 Measured under the following conditions (Area: Power requirements):

USA and Canadian models: 120 V AC, 60 Hz

Mexican model: 127 V AC, 60 Hz

European and Australian model: 230 V AC, 50 Hz

*2 Reference power output for front, center, surround, surround back and front high speakers. Depending on the sound field settings and the source, there may be no sound output.

Frequency response

Analog:

10 Hz – 100 kHz, +0.5/-2 dB (with sound field and equalizer bypassed)

Input

Analog:

Sensitivity: 500 mV/50 kilohms

S/N (*3): 105 dB (A, 500 mV (*4))

Digital (Coaxial):

Impedance: 75 ohms

S/N: 100 dB (A, 20 kHz LPF)

Digital (Optical):

S/N: 100 dB (A, 20 kHz LPF)

Output (Analog)

ZONE 2 (for STR-DN1050 only):

Voltage: 2 V/1 kilohm

SUBWOOFER:

Voltage: 2 V/1 kilohm

Equalizer

Gain levels:

±10 dB, 1 dB step

*3 INPUT SHORT (with sound field and equalizer bypassed).

*4 Weighted network, input level.

FM tuner section

Tuning range: 87.5 MHz – 108.0 MHz

Antenna (aerial): FM wire antenna (aerial)

Antenna (aerial) terminals: 75 ohms, unbalanced

AM tuner section

Tuning range (USA, Canada, and Mexico):

530 kHz – 1,710 kHz (Tuning scale: 10 kHz step)

531 kHz – 1,710 kHz (Tuning scale: 9 kHz step)

Tuning range (Europe and Australia):

531 kHz – 1,602 kHz (Tuning scale: 9 kHz step)

Antenna (aerial): Loop antenna (aerial)

Video section

Inputs/outputs

Video:

1 Vp-p, 75 ohms

COMPONENT VIDEO (for STR-DN1050 only):

Y: 1 Vp-p, 75 ohms

PB: 0.7 Vp-p, 75 ohms

PR: 0.7 Vp-p, 75 ohms

80 MHz HD Pass Through

HDMI Video

Input/Output (HDMI Repeater block)

4096 × 2160p @ 59.94/60 Hz:

2D (*1)

4096 × 2160p @ 50 Hz:

2D (*1)

3840 × 2160p @ 59.94/60 Hz:

2D (*1)

3840 × 2160p @ 50 Hz:

2D (*1)

4096 × 2160p @ 23.98/24 Hz:

2D (*2)

3840 × 2160p @ 29.97/30 Hz:

2D (*2)

3840 × 2160p @ 25 Hz:

2D (*2)

3840 × 2160p @ 23.98/24 Hz:

2D (*2)

1920 × 1080p @ 59.94/60 Hz:

2D

3D: Side-by-Side (Half)

3D: Over-Under (Top-and-Bottom)

1920 × 1080p @ 50 Hz:

2D

3D: Side-by-Side (Half)

3D: Over-Under (Top-and-Bottom)

1920 × 1080p @ 29.97/30 Hz:

2D (*3)

3D: Frame packing

3D: Side-by-Side (Half) (*3)

3D: Over-Under (Top-and-Bottom) (*3)

1920 × 1080p @ 25 Hz:

2D (*3)

3D: Frame packing

3D: Side-by-Side (Half) (*3)

3D: Over-Under (Top-and-Bottom) (*3)

1920 × 1080p @ 23.98/24 Hz:

2D (*3)

3D: Frame packing

3D: Side-by-Side (Half) (*3)

3D: Over-Under (Top-and-Bottom) (*3)

1920 × 1080i @ 59.94/60 Hz:

2D (*3)

3D: Frame packing

3D: Side-by-Side (Half) (*3)

3D: Over-Under (Top-and-Bottom) (*3)

1920 × 1080i @ 50 Hz:

2D (*3)

3D: Frame packing

3D: Side-by-Side (Half) (*3)

3D: Over-Under (Top-and-Bottom) (*3)

1280 × 720p @ 59.94/60 Hz:

2D (*3)

3D: Frame packing

3D: Side-by-Side (Half) (*3)

3D: Over-Under (Top-and-Bottom) (*3)

1280 × 720p @ 50 Hz:

2D (*3)

3D: Frame packing

3D: Side-by-Side (Half) (*3)

3D: Over-Under (Top-and-Bottom) (*3)

1280 × 720p @ 29.97/30 Hz:

2D (*3)

3D: Frame packing

3D: Side-by-Side (Half) (*3)

3D: Over-Under (Top-and-Bottom) (*3)

1280 × 720p @ 23.98/24 Hz:

2D (*3)

3D: Frame packing

3D: Side-by-Side (Half) (*3)

3D: Over-Under (Top-and-Bottom) (*3)

720 × 480p @ 59.94/60 Hz:

2D (*3)

720 × 576p @ 50 Hz:

2D (*3)

640 × 480p @ 59.94/60 Hz:

2D (*3)

*1 Supports YUV 4:2:0 / 8 bit format only.

*2 Supports 8 bit format only.

*3 These formats are also supported by MHL connection.

MHL section

Supported MHL version: Incorporates MHL 2

Maximum current: 900 mA

iPhone/iPad/iPod section

DC 5V 1.0 A MAX

USB works with iPhone 5s, iPhone 5c, iPhone 5, iPhone 4s, iPhone 4, iPhone 3GS, iPhone 3G, iPod touch (2nd through 5th generation), iPod classic, and iPod nano (3rd through 7th generation).

BLUETOOTH technology works with iPhone 5s, iPhone 5c, iPhone 5, iPhone 4s, iPhone 4, iPhone 3GS, and iPod touch (4th and 5th generation).

AirPlay works with iPhone, iPad, and iPod touch with iOS 4.3.3 or later, Mac with OS X Mountain Lion, and Mac and PC with iTunes 10.2.2 or later.

You can use “SongPal” app with this receiver via BLUETOOTH or network connection.

You can only charge the iPhone/iPod when they are connected to the USB port while the receiver is turned on.

Network section:

Ethernet LAN: 10BASE-T/100BASE-TX

Wireless LAN:

Compatible standards: IEEE 802.11 b/g

Security:

WEP 64 bit, WEP 128 bit, WPA/WPA2-PSK (AES), WPA/WPA2-PSK (TKIP)

Radio frequency:

2.4 GHz

BLUETOOTH section

Communication system: BLUETOOTH Specification version 3.0

Output: BLUETOOTH Specification Power Class 2

Maximum communication range: Line of sight approx. 10 m (33 feet) (*1)

Frequency band: 2.4 GHz band (2.4000 GHz – 2.4835 GHz)

Modulation method: FHSS (Freq Hopping Spread Spectrum)

Compatible BLUETOOTH profiles (*2): A2DP (Advanced Audio Distribution Profile), AVRCP 1.3 (Audio Video Remote Control Profile)

Supported Codecs (*3): SBC (*4), AAC, aptX

Transmission range (A2DP): 20 Hz – 20,000 Hz (Sampling frequency 44.1 kHz)

*1 The actual range will vary depending on factors such as obstacles between devices, magnetic fields around a microwave oven, static electricity, cordless phone, reception sensitivity, antenna's performance, operating system, software application, etc.

*2 BLUETOOTH standard profiles indicate the purpose of BLUETOOTH communication between devices.

*3 Codec: Audio signal compression and conversion format

*4 Subband Codec

General section

Power requirements

USA and Canadian models: 120 V AC, 60 Hz

Mexican model: 127 V AC, 60 Hz

European model: 230 V AC, 50/60 Hz

Australian model: 230 V AC, 50 Hz

Power consumption

240 W

Power consumption (during standby mode)

STR-DN1050:

0.3 W (When [Control for HDMI], [Pass Through], [Network Standby] (*), and [Bluetooth Standby] are set to [Off], and the receiver in zone 2 is turned off.)

0.7 W (When [Control for HDMI] is set to [On], [Pass Through], [Network Standby] (*), and [Bluetooth Standby] are set to [Off], and the receiver in zone 2 is turned off.)

1.3 W (When [Control for HDMI] and [Bluetooth Standby] are set to [On], [Pass Through] and [Network Standby] (*) are set to [Off], and the receiver in zone 2 is turned off.)

STR-DN850:

0.3 W (When [Control for HDMI], [Pass Through], [Network Standby] (*), and [Bluetooth Standby] are set to [Off].)

0.5 W (When [Control for HDMI] is set to [On], [Pass Through], [Network Standby] (*), and [Bluetooth Standby] are set to [Off].)

1.0 W (When [Control for HDMI] and [Bluetooth Standby] are set to [On], [Pass Through] and [Network Standby] (*) are set to [Off].)

* For USA and Canadian models only

Dimensions (width/height/depth) (Approx.)

STR-DN1050: 430 mm × 172 mm × 329.4 mm (17 in × 6 7/8 in × 13 in)

STR-DN850: 430 mm × 156 mm × 329.4 mm (17 in × 6 1/4 in × 13 in)

including projecting parts and controls

Mass (Approx.)

STR-DN1050: 10.0 kg (22 lb 1 oz)

STR-DN850: 8.0 kg (17 lb 11 oz)

Design and specifications are subject to change without notice.

Related Topic

- [Compatible USB devices and USB specifications](#)
- [Compatible iPhone/iPod/iPad models](#)

[Notes on use](#)

4-488-938-11(1)

Copyright 2014 Sony Corporation



MULTI CHANNEL AV RECEIVER
STR-DN1050/STR-DN850

Trademarks

- This receiver incorporates Dolby (*) Digital and Pro Logic Surround and the DTS (**) Digital Surround System.
 - * Manufactured under license from Dolby Laboratories. Dolby, Pro Logic, Surround EX, and the double-D symbol are trademarks of Dolby Laboratories.
 - ** For DTS patents, see <http://patents.dts.com>. Manufactured under license from DTS Licensing Limited. DTS, DTS-HD, the Symbol, & DTS and the Symbol together are registered trademarks, and DTS-HD Master Audio is a trademark of DTS, Inc. © DTS, Inc. All Rights Reserved.
- This receiver incorporates High-Definition Multimedia Interface (HDMI™) technology. The terms HDMI and HDMI High-Definition Multimedia Interface, and the HDMI Logo are trademarks or registered trademarks of HDMI Licensing LLC in the United States and other countries.
- AirPlay, iPad, iPhone, iPod, iPod classic, iPod nano, and iPod touch are trademarks of Apple Inc., registered in the U.S. and other countries. App Store is a service mark of Apple Inc.
- All other trademarks and registered trademarks are of their respective holders. In this manual, ™ and ® marks are not specified.
- “Made for iPod,” “Made for iPhone,” and “Made for iPad” mean that an electronic accessory has been designed to connect specifically to iPod, iPhone, or iPad, respectively, and has been certified by the developer to meet Apple performance standards.

Apple is not responsible for the operation of this device or its compliance with safety and regulatory standards. Please note that the use of this accessory with iPod, iPhone, or iPad, may affect wireless performance.
- DLNA™, the DLNA Logo and DLNA CERTIFIED™ are trademarks, service marks, or certification marks of the Digital Living Network Alliance.
- “Sony Entertainment Network” logo and “Sony Entertainment Network” are trademarks of Sony Corporation.
- Windows and the Windows logo are either registered trademarks or trademarks of Microsoft Corporation in the United States and/or other countries.
- This product is protected by certain intellectual property rights of Microsoft Corporation. Use or distribution of such technology outside of this product is prohibited without a license from Microsoft or an authorized Microsoft subsidiary.
- MPEG Layer-3 audio coding technology and patents licensed from Fraunhofer IIS and Thomson.
- “x.v.Color (x.v.Colour)” and “x.v.Color (x.v.Colour)” logo are trademarks of Sony Corporation.
- “BRAVIA” is a trademark of Sony Corporation.
- “PlayStation” is a registered trademark of Sony Computer Entertainment Inc.
- “WALKMAN” and “WALKMAN” logo are registered trademarks of Sony Corporation.
- MICROVAULT is a trademark of Sony Corporation.
- VAIO and VAIO Media are registered trademarks of Sony Corporation.
- The Wi-Fi CERTIFIED Logo is a certification mark of Wi-Fi Alliance.
- MHL, Mobile High-Definition Link and the MHL Logo are trademarks or registered trademarks of MHL Licensing, LLC.
- The BLUETOOTH® word mark and logos are registered trademarks owned by Bluetooth SIG, Inc. and any use of such marks by Sony Corporation is under license. Other trademarks and trade names are those of their respective

owners.

- © 2013 CSR plc and its group companies. The aptX® mark and the aptX logo are trade marks of CSR plc or one of its group companies and may be registered in one or more jurisdictions.
- The N Mark is a trademark or registered trademark of NFC Forum, Inc. in the United States and in other countries.
- Android™ is a trademark of Google Inc.
- Google Play™ is a trademark of Google Inc.
- “Spotify” and “Spotify” logos are trademarks of the Spotify Group.

Notes on use

4-488-938-11(1)

Copyright 2014 Sony Corporation



MULTI CHANNEL AV RECEIVER
STR-DN1050/STR-DN850

Software License Information

WPA Supplicant

Copyright (c) 2003-2013, Jouni Malinen <j@w1.fi> and contributors

All Rights Reserved.

This program is licensed under the BSD license (the one with advertisement clause removed).

If you are submitting changes to the project, please see CONTRIBUTIONS file for more instructions.

License

This software may be distributed, used, and modified under the terms of BSD license:

Redistribution and use in source and binary forms, with or without modification, are permitted provided that the following conditions are met:

1. Redistributions of source code must retain the above copyright notice, this list of conditions and the following disclaimer.
2. Redistributions in binary form must reproduce the above copyright notice, this list of conditions and the following disclaimer in the documentation and/or other materials provided with the distribution.
3. Neither the name(s) of the above-listed copyright holder(s) nor the names of its contributors may be used to endorse or promote products derived from this software without specific prior written permission.

THIS SOFTWARE IS PROVIDED BY THE COPYRIGHT HOLDERS AND CONTRIBUTORS "AS IS" AND ANY EXPRESS OR IMPLIED WARRANTIES, INCLUDING, BUT NOT LIMITED TO, THE IMPLIED WARRANTIES OF MERCHANTABILITY AND FITNESS FOR A PARTICULAR PURPOSE ARE DISCLAIMED. IN NO EVENT SHALL THE COPYRIGHT OWNER OR CONTRIBUTORS BE LIABLE FOR ANY DIRECT, INDIRECT, INCIDENTAL, SPECIAL, EXEMPLARY, OR CONSEQUENTIAL DAMAGES (INCLUDING, BUT NOT LIMITED TO, PROCUREMENT OF SUBSTITUTE GOODS OR SERVICES; LOSS OF USE, DATA, OR PROFITS; OR BUSINESS INTERRUPTION) HOWEVER CAUSED AND ON ANY THEORY OF LIABILITY, WHETHER IN CONTRACT, STRICT LIABILITY, OR TORT (INCLUDING NEGLIGENCE OR OTHERWISE) ARISING IN ANY WAY OUT OF THE USE OF THIS SOFTWARE, EVEN IF ADVISED OF THE POSSIBILITY OF SUCH DAMAGE.

libFLAC

Copyright (C) 2000, 2001, 2002, 2003, 2004, 2005, 2006, 2007 Josh Coalson

Redistribution and use in source and binary forms, with or without modification, are permitted provided that the following conditions are met:

- Redistributions of source code must retain the above copyright notice, this list of conditions and the following disclaimer.
- Redistributions in binary form must reproduce the above copyright notice, this list of conditions and the following disclaimer in the documentation and/or other materials provided with the distribution.
- Neither the name of the Xiph.org Foundation nor the names of its contributors may be used to endorse or promote

products derived from this software without specific prior written permission.

THIS SOFTWARE IS PROVIDED BY THE COPYRIGHT HOLDERS AND CONTRIBUTORS ``AS IS" AND ANY EXPRESS OR IMPLIED WARRANTIES, INCLUDING, BUT NOT LIMITED TO, THE IMPLIED WARRANTIES OF MERCHANTABILITY AND FITNESS FOR A PARTICULAR PURPOSE ARE DISCLAIMED. IN NO EVENT SHALL THE FOUNDATION OR CONTRIBUTORS BE LIABLE FOR ANY DIRECT, INDIRECT, INCIDENTAL, SPECIAL, EXEMPLARY, OR CONSEQUENTIAL DAMAGES (INCLUDING, BUT NOT LIMITED TO, PROCUREMENT OF SUBSTITUTE GOODS OR SERVICES; LOSS OF USE, DATA, OR PROFITS; OR BUSINESS INTERRUPTION) HOWEVER CAUSED AND ON ANY THEORY OF LIABILITY, WHETHER IN CONTRACT, STRICT LIABILITY, OR TORT (INCLUDING NEGLIGENCE OR OTHERWISE) ARISING IN ANY WAY OUT OF THE USE OF THIS SOFTWARE, EVEN IF ADVISED OF THE POSSIBILITY OF SUCH DAMAGE.

ALAC

Copyright (c) 2002-2008 Apple Inc. All rights reserved.

Apache License

Version 2.0, January 2004

<http://www.apache.org/licenses/>

TERMS AND CONDITIONS FOR USE, REPRODUCTION, AND DISTRIBUTION

1. Definitions.

"License" shall mean the terms and conditions for use, reproduction, and distribution as defined by Sections 1 through 9 of this document.

"Licensor" shall mean the copyright owner or entity authorized by the copyright owner that is granting the License.

"Legal Entity" shall mean the union of the acting entity and all other entities that control, are controlled by, or are under common control with that entity. For the purposes of this definition, "control" means (i) the power, direct or indirect, to cause the direction or management of such entity, whether by contract or otherwise, or (ii) ownership of fifty percent (50%) or more of the outstanding shares, or (iii) beneficial ownership of such entity.

"You" (or "Your") shall mean an individual or Legal Entity exercising permissions granted by this License.

"Source" form shall mean the preferred form for making modifications, including but not limited to software source code, documentation source, and configuration files.

"Object" form shall mean any form resulting from mechanical transformation or translation of a Source form, including but not limited to compiled object code, generated documentation, and conversions to other media types.

"Work" shall mean the work of authorship, whether in Source or Object form, made available under the License, as indicated by a copyright notice that is included in or attached to the work (an example is provided in the Appendix below).

"Derivative Works" shall mean any work, whether in Source or Object form, that is based on (or derived from) the Work and for which the editorial revisions, annotations, elaborations, or other modifications represent, as a whole, an original work of authorship. For the purposes of this License, Derivative Works shall not include works that remain separable from, or merely link (or bind by name) to the interfaces of, the Work and Derivative Works thereof.

"Contribution" shall mean any work of authorship, including the original version of the Work and any modifications or additions to that Work or Derivative Works thereof, that is intentionally submitted to Licensor for inclusion in the Work by the copyright owner or by an individual or Legal Entity authorized to submit on behalf of the copyright owner. For the purposes of this definition, "submitted" means any form of electronic, verbal, or written communication sent to the Licensor or its representatives, including but not limited to communication on electronic mailing lists, source code control systems, and issue tracking systems that are managed by, or on behalf of, the Licensor for the purpose of discussing and improving the Work, but excluding communication that is conspicuously marked or otherwise designated in writing by the copyright owner as "Not a Contribution."

"Contributor" shall mean Licensor and any individual or Legal Entity on behalf of whom a Contribution has been

received by Licensor and subsequently incorporated within the Work.

2. **Grant of Copyright License.** Subject to the terms and conditions of this License, each Contributor hereby grants to You a perpetual, worldwide, non-exclusive, no-charge, royalty-free, irrevocable copyright license to reproduce, prepare Derivative Works of, publicly display, publicly perform, sublicense, and distribute the Work and such Derivative Works in Source or Object form.
3. **Grant of Patent License.** Subject to the terms and conditions of this License, each Contributor hereby grants to You a perpetual, worldwide, non-exclusive, no-charge, royalty-free, irrevocable (except as stated in this section) patent license to make, have made, use, offer to sell, sell, import, and otherwise transfer the Work, where such license applies only to those patent claims licensable by such Contributor that are necessarily infringed by their Contribution(s) alone or by combination of their Contribution(s) with the Work to which such Contribution(s) was submitted. If You institute patent litigation against any entity (including a cross-claim or counterclaim in a lawsuit) alleging that the Work or a Contribution incorporated within the Work constitutes direct or contributory patent infringement, then any patent licenses granted to You under this License for that Work shall terminate as of the date such litigation is filed.
4. **Redistribution.** You may reproduce and distribute copies of the Work or Derivative Works thereof in any medium, with or without modifications, and in Source or Object form, provided that You meet the following conditions:
 - (a) You must give any other recipients of the Work or Derivative Works a copy of this License; and
 - (b) You must cause any modified files to carry prominent notices stating that You changed the files; and
 - (c) You must retain, in the Source form of any Derivative Works that You distribute, all copyright, patent, trademark, and attribution notices from the Source form of the Work, excluding those notices that do not pertain to any part of the Derivative Works; and
 - (d) If the Work includes a "NOTICE" text file as part of its distribution, then any Derivative Works that You distribute must include a readable copy of the attribution notices contained within such NOTICE file, excluding those notices that do not pertain to any part of the Derivative Works, in at least one of the following places: within a NOTICE text file distributed as part of the Derivative Works; within the Source form or documentation, if provided along with the Derivative Works; or, within a display generated by the Derivative Works, if and wherever such third-party notices normally appear. The contents of the NOTICE file are for informational purposes only and do not modify the License. You may add Your own attribution notices within Derivative Works that You distribute, alongside or as an addendum to the NOTICE text from the Work, provided that such additional attribution notices cannot be construed as modifying the License.

You may add Your own copyright statement to Your modifications and may provide additional or different license terms and conditions for use, reproduction, or distribution of Your modifications, or for any such Derivative Works as a whole, provided Your use, reproduction, and distribution of the Work otherwise complies with the conditions stated in this License.

5. **Submission of Contributions.** Unless You explicitly state otherwise, any Contribution intentionally submitted for inclusion in the Work by You to the Licensor shall be under the terms and conditions of this License, without any additional terms or conditions. Notwithstanding the above, nothing herein shall supersede or modify the terms of any separate license agreement you may have executed with Licensor regarding such Contributions.
6. **Trademarks.** This License does not grant permission to use the trade names, trademarks, service marks, or product names of the Licensor, except as required for reasonable and customary use in describing the origin of the Work and reproducing the content of the NOTICE file.
7. **Disclaimer of Warranty.** Unless required by applicable law or agreed to in writing, Licensor provides the Work (and each Contributor provides its Contributions) on an "AS IS" BASIS, WITHOUT WARRANTIES OR CONDITIONS OF ANY KIND, either express or implied, including, without limitation, any warranties or conditions of TITLE, NON-INFRINGEMENT, MERCHANTABILITY, or FITNESS FOR A PARTICULAR PURPOSE. You are solely responsible for determining the appropriateness of using or redistributing the Work and assume any risks associated with Your

exercise of permissions under this License.

8. Limitation of Liability. In no event and under no legal theory, whether in tort (including negligence), contract, or otherwise, unless required by applicable law (such as deliberate and grossly negligent acts) or agreed to in writing, shall any Contributor be liable to You for damages, including any direct, indirect, special, incidental, or consequential damages of any character arising as a result of this License or out of the use or inability to use the Work (including but not limited to damages for loss of goodwill, work stoppage, computer failure or malfunction, or any and all other commercial damages or losses), even if such Contributor has been advised of the possibility of such damages.
9. Accepting Warranty or Additional Liability. While redistributing the Work or Derivative Works thereof, You may choose to offer, and charge a fee for, acceptance of support, warranty, indemnity, or other liability obligations and/or rights consistent with this License. However, in accepting such obligations, You may act only on Your own behalf and on Your sole responsibility, not on behalf of any other Contributor, and only if You agree to indemnify, defend, and hold each Contributor harmless for any liability incurred by, or claims asserted against, such Contributor by reason of your accepting any such warranty or additional liability.

END OF TERMS AND CONDITIONS

APPENDIX: How to apply the Apache License to your work.

To apply the Apache License to your work, attach the following boilerplate notice, with the fields enclosed by brackets "[]" replaced with your own identifying information. (Don't include the brackets!) The text should be enclosed in the appropriate comment syntax for the file format. We also recommend that a file or class name and description of purpose be included on the same "printed page" as the copyright notice for easier identification within third-party archives.

Copyright [yyyy] [name of copyright owner]

Licensed under the Apache License, Version 2.0 (the "License"); you may not use this file except in compliance with the License. You may obtain a copy of the License at

<http://www.apache.org/licenses/LICENSE-2.0>

Unless required by applicable law or agreed to in writing, software distributed under the License is distributed on an "AS IS" BASIS, WITHOUT WARRANTIES OR CONDITIONS OF ANY KIND, either express or implied. See the License for the specific language governing permissions and limitations under the License.

mDNSResponder

Copyright (c) 2002-2008 Apple Inc. All rights reserved.

Apache License

Version 2.0, January 2004

<http://www.apache.org/licenses/>

TERMS AND CONDITIONS FOR USE, REPRODUCTION, AND DISTRIBUTION

1. Definitions.

"License" shall mean the terms and conditions for use, reproduction, and distribution as defined by Sections 1 through 9 of this document.

"Licensor" shall mean the copyright owner or entity authorized by the copyright owner that is granting the License.

"Legal Entity" shall mean the union of the acting entity and all other entities that control, are controlled by, or are under common control with that entity. For the purposes of this definition, "control" means (i) the power, direct or indirect, to cause the direction or management of such entity, whether by contract or otherwise, or (ii) ownership of fifty percent (50%) or more of the outstanding shares, or (iii) beneficial ownership of such entity.

"You" (or "Your") shall mean an individual or Legal Entity exercising permissions granted by this License.

"Source" form shall mean the preferred form for making modifications, including but not limited to software source code, documentation source, and configuration files.

"Object" form shall mean any form resulting from mechanical transformation or translation of a Source form, including but not limited to compiled object code, generated documentation, and conversions to other media types. "Work" shall mean the work of authorship, whether in Source or Object form, made available under the License, as indicated by a copyright notice that is included in or attached to the work (an example is provided in the Appendix below).

"Derivative Works" shall mean any work, whether in Source or Object form, that is based on (or derived from) the Work and for which the editorial revisions, annotations, elaborations, or other modifications represent, as a whole, an original work of authorship. For the purposes of this License, Derivative Works shall not include works that remain separable from, or merely link (or bind by name) to the interfaces of, the Work and Derivative Works thereof.

"Contribution" shall mean any work of authorship, including the original version of the Work and any modifications or additions to that Work or Derivative Works thereof, that is intentionally submitted to Licensor for inclusion in the Work by the copyright owner or by an individual or Legal Entity authorized to submit on behalf of the copyright owner. For the purposes of this definition, "submitted" means any form of electronic, verbal, or written communication sent to the Licensor or its representatives, including but not limited to communication on electronic mailing lists, source code control systems, and issue tracking systems that are managed by, or on behalf of, the Licensor for the purpose of discussing and improving the Work, but excluding communication that is conspicuously marked or otherwise designated in writing by the copyright owner as "Not a Contribution."

"Contributor" shall mean Licensor and any individual or Legal Entity on behalf of whom a Contribution has been received by Licensor and subsequently incorporated within the Work.

2. Grant of Copyright License. Subject to the terms and conditions of this License, each Contributor hereby grants to You a perpetual, worldwide, non-exclusive, no-charge, royalty-free, irrevocable copyright license to reproduce, prepare Derivative Works of, publicly display, publicly perform, sublicense, and distribute the Work and such Derivative Works in Source or Object form.
3. Grant of Patent License. Subject to the terms and conditions of this License, each Contributor hereby grants to You a perpetual, worldwide, non-exclusive, no-charge, royalty-free, irrevocable (except as stated in this section) patent license to make, have made, use, offer to sell, sell, import, and otherwise transfer the Work, where such license applies only to those patent claims licensable by such Contributor that are necessarily infringed by their Contribution(s) alone or by combination of their Contribution(s) with the Work to which such Contribution(s) was submitted. If You institute patent litigation against any entity (including a cross-claim or counterclaim in a lawsuit) alleging that the Work or a Contribution incorporated within the Work constitutes direct or contributory patent infringement, then any patent licenses granted to You under this License for that Work shall terminate as of the date such litigation is filed.
4. Redistribution. You may reproduce and distribute copies of the Work or Derivative Works thereof in any medium, with or without modifications, and in Source or Object form, provided that You meet the following conditions:
 - (a) You must give any other recipients of the Work or Derivative Works a copy of this License; and
 - (b) You must cause any modified files to carry prominent notices stating that You changed the files; and
 - (c) You must retain, in the Source form of any Derivative Works that You distribute, all copyright, patent, trademark, and attribution notices from the Source form of the Work, excluding those notices that do not pertain to any part of the Derivative Works; and
 - (d) If the Work includes a "NOTICE" text file as part of its distribution, then any Derivative Works that You distribute must include a readable copy of the attribution notices contained within such NOTICE file, excluding those notices that do not pertain to any part of the Derivative Works, in at least one of the following places: within a NOTICE text file distributed as part of the Derivative Works; within the Source form or documentation, if provided along with the Derivative Works; or, within a display generated by the Derivative Works, if and wherever such third-party notices normally appear. The contents of the NOTICE file are for informational purposes only and do not modify the License. You may add Your own attribution notices within Derivative Works that You distribute, alongside or as an

addendum to the NOTICE text from the Work, provided that such additional attribution notices cannot be construed as modifying the License.

You may add Your own copyright statement to Your modifications and may provide additional or different license terms and conditions for use, reproduction, or distribution of Your modifications, or for any such Derivative Works as a whole, provided Your use, reproduction, and distribution of the Work otherwise complies with the conditions stated in this License.

5. Submission of Contributions. Unless You explicitly state otherwise, any Contribution intentionally submitted for inclusion in the Work by You to the Licensor shall be under the terms and conditions of this License, without any additional terms or conditions. Notwithstanding the above, nothing herein shall supersede or modify the terms of any separate license agreement you may have executed with Licensor regarding such Contributions.
6. Trademarks. This License does not grant permission to use the trade names, trademarks, service marks, or product names of the Licensor, except as required for reasonable and customary use in describing the origin of the Work and reproducing the content of the NOTICE file.
7. Disclaimer of Warranty. Unless required by applicable law or agreed to in writing, Licensor provides the Work (and each Contributor provides its Contributions) on an "AS IS" BASIS, WITHOUT WARRANTIES OR CONDITIONS OF ANY KIND, either express or implied, including, without limitation, any warranties or conditions of TITLE, NON-INFRINGEMENT, MERCHANTABILITY, or FITNESS FOR A PARTICULAR PURPOSE. You are solely responsible for determining the appropriateness of using or redistributing the Work and assume any risks associated with Your exercise of permissions under this License.
8. Limitation of Liability. In no event and under no legal theory, whether in tort (including negligence), contract, or otherwise, unless required by applicable law (such as deliberate and grossly negligent acts) or agreed to in writing, shall any Contributor be liable to You for damages, including any direct, indirect, special, incidental, or consequential damages of any character arising as a result of this License or out of the use or inability to use the Work (including but not limited to damages for loss of goodwill, work stoppage, computer failure or malfunction, or any and all other commercial damages or losses), even if such Contributor has been advised of the possibility of such damages.
9. Accepting Warranty or Additional Liability. While redistributing the Work or Derivative Works thereof, You may choose to offer, and charge a fee for, acceptance of support, warranty, indemnity, or other liability obligations and/or rights consistent with this License. However, in accepting such obligations, You may act only on Your own behalf and on Your sole responsibility, not on behalf of any other Contributor, and only if You agree to indemnify, defend, and hold each Contributor harmless for any liability incurred by, or claims asserted against, such Contributor by reason of your accepting any such warranty or additional liability.

END OF TERMS AND CONDITIONS

APPENDIX: How to apply the Apache License to your work.

To apply the Apache License to your work, attach the following boilerplate notice, with the fields enclosed by brackets "[]" replaced with your own identifying information. (Don't include the brackets!) The text should be enclosed in the appropriate comment syntax for the file format. We also recommend that a file or class name and description of purpose be included on the same "printed page" as the copyright notice for easier identification within third-party archives.

Copyright [yyyy] [name of copyright owner]

Licensed under the Apache License, Version 2.0 (the "License"); you may not use this file except in compliance with the License. You may obtain a copy of the License at

<http://www.apache.org/licenses/LICENSE-2.0>

Unless required by applicable law or agreed to in writing, software distributed under the License is distributed on an "AS IS" BASIS, WITHOUT WARRANTIES OR CONDITIONS OF ANY KIND, either express or implied. See the License for the specific language governing permissions and limitations under the License.

Expat

Copyright (c) 1998, 1999, 2000 Thai Open Source Software Center Ltd and Clark Cooper

Copyright (c) 2001, 2002, 2003, 2004, 2005, 2006 Expat maintainers.

Permission is hereby granted, free of charge, to any person obtaining a copy of this software and associated documentation files (the Software), to deal in the Software without restriction, including without limitation the rights to use, copy, modify, merge, publish, distribute, sublicense, and/or sell copies of the Software, and to permit persons to whom the Software is furnished to do so, subject to the following conditions:

The above copyright notice and this permission notice shall be included in all copies or substantial portions of the Software.

THE SOFTWARE IS PROVIDED "AS IS", WITHOUT WARRANTY OF ANY KIND, EXPRESS OR IMPLIED, INCLUDING BUT NOT LIMITED TO THE WARRANTIES OF MERCHANTABILITY, FITNESS FOR A PARTICULAR PURPOSE AND NONINFRINGEMENT. IN NO EVENT SHALL THE AUTHORS OR COPYRIGHT HOLDERS BE LIABLE FOR ANY CLAIM, DAMAGES OR OTHER LIABILITY, WHETHER IN AN ACTION OF CONTRACT, TORT OR OTHERWISE, ARISING FROM, OUT OF OR IN CONNECTION WITH THE SOFTWARE OR THE USE OR OTHER DEALINGS IN THE SOFTWARE.

This product incorporates Spotify software which is subject to 3rd party licenses found here:

www.spotify.com/connect/third-party-licenses

Boost

<http://www.boost.org/>

Boost Software License - Version 1.0 - August 17th, 2003

Permission is hereby granted, free of charge, to any person or organization obtaining a copy of the software and accompanying documentation covered by this license (the "Software") to use, reproduce, display, distribute, execute, and transmit the Software, and to prepare derivative works of the Software, and to permit third-parties to whom the Software is furnished to do so, all subject to the following:

The copyright notices in the Software and this entire statement, including the above license grant, this restriction and the following disclaimer, must be included in all copies of the Software, in whole or in part, and all derivative works of the Software, unless such copies or derivative works are solely in the form of machine-executable object code generated by a source language processor.

THE SOFTWARE IS PROVIDED "AS IS", WITHOUT WARRANTY OF ANY KIND, EXPRESS OR IMPLIED, INCLUDING BUT NOT LIMITED TO THE WARRANTIES OF MERCHANTABILITY, FITNESS FOR A PARTICULAR PURPOSE, TITLE AND NON-INFRINGEMENT. IN NO EVENT SHALL THE COPYRIGHT HOLDERS OR ANYONE DISTRIBUTING THE SOFTWARE BE LIABLE FOR ANY DAMAGES OR OTHER LIABILITY, WHETHER IN CONTRACT, TORT OR OTHERWISE, ARISING FROM, OUT OF OR IN CONNECTION WITH THE SOFTWARE OR THE USE OR OTHER DEALINGS IN THE SOFTWARE.

Expat

<http://www.jclark.com/xml/expat.html>

Expat License. Copyright (c) 1998, 1999, 2000 Thai Open Source Software Center Ltd

Permission is hereby granted, free of charge, to any person obtaining a copy of this software and associated documentation files (the "Software"), to deal in the Software without restriction, including without limitation the rights to use, copy, modify, merge, publish, distribute, sublicense, and/or sell copies of the Software, and to permit persons to whom the Software is furnished to do so, subject to the following conditions:

The above copyright notice and this permission notice shall be included in all copies or substantial portions of the Software.

THE SOFTWARE IS PROVIDED "AS IS", WITHOUT WARRANTY OF ANY KIND, EXPRESS OR IMPLIED, INCLUDING BUT NOT LIMITED TO THE WARRANTIES OF MERCHANTABILITY, FITNESS FOR A PARTICULAR PURPOSE AND NONINFRINGEMENT. IN NO EVENT SHALL THE AUTHORS OR COPYRIGHT HOLDERS BE LIABLE FOR ANY CLAIM, DAMAGES OR OTHER LIABILITY, WHETHER IN AN ACTION OF CONTRACT, TORT OR OTHERWISE, ARISING FROM, OUT OF OR IN CONNECTION WITH THE SOFTWARE OR THE USE OR OTHER DEALINGS IN THE SOFTWARE.

FastDelegate

<http://www.codeproject.com/KB/cpp/FastDelegate.aspx>

THE WORK (AS DEFINED BELOW) IS PROVIDED UNDER THE TERMS OF THIS CODE PROJECT OPEN LICENSE ("LICENSE"). THE WORK IS PROTECTED BY COPYRIGHT AND/OR OTHER APPLICABLE LAW. ANY USE OF THE WORK OTHER THAN AS AUTHORIZED UNDER THIS LICENSE OR COPYRIGHT LAW IS PROHIBITED.

BY EXERCISING ANY RIGHTS TO THE WORK PROVIDED HEREIN, YOU ACCEPT AND AGREE TO BE BOUND BY THE TERMS OF THIS LICENSE. THE AUTHOR GRANTS YOU THE RIGHTS CONTAINED HEREIN IN CONSIDERATION OF YOUR ACCEPTANCE OF SUCH TERMS AND CONDITIONS. IF YOU DO NOT AGREE TO ACCEPT AND BE BOUND BY THE TERMS OF THIS LICENSE, YOU CANNOT MAKE ANY USE OF THE WORK.

Definitions.

"Articles" means, collectively, all articles written by Author which describes how the Source Code and Executable Files for the Work may be used by a user.

"Author" means the individual or entity that offers the Work under the terms of this License.

"Derivative Work" means a work based upon the Work or upon the Work and other pre-existing works.

"Executable Files" refer to the executables, binary files, configuration and any required data files included in the Work.

"Publisher" means the provider of the website, magazine, CD-ROM, DVD or other medium from or by which the Work is obtained by You.

"Source Code" refers to the collection of source code and configuration files used to create the Executable Files.

"Standard Version" refers to such a Work if it has not been modified, or has been modified in accordance with the consent of the Author, such consent being in the full discretion of the Author.

"Work" refers to the collection of files distributed by the Publisher, including the Source Code, Executable Files, binaries, data files, documentation, whitepapers and the Articles.

"You" is you, an individual or entity wishing to use the Work and exercise your rights under this License.

Fair Use/Fair Use Rights. Nothing in this License is intended to reduce, limit, or restrict any rights arising from fair use, fair dealing, first sale or other limitations on the exclusive rights of the copyright owner under copyright law or other applicable laws.

License Grant. Subject to the terms and conditions of this License, the Author hereby grants You a worldwide, royalty-free, non-exclusive, perpetual (for the duration of the applicable copyright) license to exercise the rights in the Work as stated below:

You may use the standard version of the Source Code or Executable Files in Your own applications.

You may apply bug fixes, portability fixes and other modifications obtained from the Public Domain or from the Author. A Work modified in such a way shall still be considered the standard version and will be subject to this License.

You may otherwise modify Your copy of this Work (excluding the Articles) in any way to create a Derivative Work, provided that You insert a prominent notice in each changed file stating how, when and where You changed that file.

You may distribute the standard version of the Executable Files and Source Code or Derivative Work in aggregate with other (possibly commercial) programs as part of a larger (possibly commercial) software distribution.

The Articles discussing the Work published in any form by the author may not be distributed or republished without the Author's consent. The author retains copyright to any such Articles. You may use the Executable Files and Source Code pursuant to this License but you may not repost or republish or otherwise distribute or make available the Articles,

without the prior written consent of the Author.

Any subroutines or modules supplied by You and linked into the Source Code or Executable Files this Work shall not be considered part of this Work and will not be subject to the terms of this License.

Patent License. Subject to the terms and conditions of this License, each Author hereby grants to You a perpetual, worldwide, non-exclusive, no-charge, royalty-free, irrevocable (except as stated in this section) patent license to make, have made, use, import, and otherwise transfer the Work.

Restrictions. The license granted in Section 3 above is expressly made subject to and limited by the following restrictions:

You agree not to remove any of the original copyright, patent, trademark, and attribution notices and associated disclaimers that may appear in the Source Code or Executable Files.

You agree not to advertise or in any way imply that this Work is a product of Your own.

The name of the Author may not be used to endorse or promote products derived from the Work without the prior written consent of the Author.

You agree not to sell, lease, or rent any part of the Work. This does not restrict you from including the Work or any part of the Work inside a larger software distribution that itself is being sold. The Work by itself, though, cannot be sold, leased or rented.

You may distribute the Executable Files and Source Code only under the terms of this License, and You must include a copy of, or the Uniform Resource Identifier for, this License with every copy of the Executable Files or Source Code You distribute and ensure that anyone receiving such Executable Files and Source Code agrees that the terms of this License apply to such Executable Files and/or Source Code. You may not offer or impose any terms on the Work that alter or restrict the terms of this License or the recipients' exercise of the rights granted hereunder. You may not sublicense the Work. You must keep intact all notices that refer to this License and to the disclaimer of warranties. You may not distribute the Executable Files or Source Code with any technological measures that control access or use of the Work in a manner inconsistent with the terms of this License.

You agree not to use the Work for illegal, immoral or improper purposes, or on pages containing illegal, immoral or improper material. The Work is subject to applicable export laws. You agree to comply with all such laws and regulations that may apply to the Work after Your receipt of the Work.

Representations, Warranties and Disclaimer. THIS WORK IS PROVIDED "AS IS", "WHERE IS" AND "AS AVAILABLE", WITHOUT ANY EXPRESS OR IMPLIED WARRANTIES OR CONDITIONS OR GUARANTEES. YOU, THE USER, ASSUME ALL RISK IN ITS USE, INCLUDING COPYRIGHT INFRINGEMENT, PATENT INFRINGEMENT, SUITABILITY, ETC. AUTHOR EXPRESSLY DISCLAIMS ALL EXPRESS, IMPLIED OR STATUTORY WARRANTIES OR CONDITIONS, INCLUDING WITHOUT LIMITATION, WARRANTIES OR CONDITIONS OF MERCHANTABILITY, MERCHANTABILITY QUALITY OR FITNESS FOR A PARTICULAR PURPOSE, OR ANY WARRANTY OF TITLE OR NON-INFRINGEMENT, OR THAT THE WORK (OR ANY PORTION THEREOF) IS CORRECT, USEFUL, BUG-FREE OR FREE OF VIRUSES. YOU MUST PASS THIS DISCLAIMER ON WHENEVER YOU DISTRIBUTE THE WORK OR DERIVATIVE WORKS.

Indemnity. You agree to defend, indemnify and hold harmless the Author and the Publisher from and against any claims, suits, losses, damages, liabilities, costs, and expenses (including reasonable legal or attorneys' fees) resulting from or relating to any use of the Work by You.

Limitation on Liability. EXCEPT TO THE EXTENT REQUIRED BY APPLICABLE LAW, IN NO EVENT WILL THE AUTHOR OR THE PUBLISHER BE LIABLE TO YOU ON ANY LEGAL THEORY FOR ANY SPECIAL, INCIDENTAL, CONSEQUENTIAL, PUNITIVE OR EXEMPLARY DAMAGES ARISING OUT OF THIS LICENSE OR THE USE OF THE WORK OR OTHERWISE, EVEN IF THE AUTHOR OR THE PUBLISHER HAS BEEN ADVISED OF THE POSSIBILITY OF SUCH DAMAGES.

Termination.

This License and the rights granted hereunder will terminate automatically upon any breach by You of any term of this

License. Individuals or entities who have received Derivative Works from You under this License, however, will not have their licenses terminated provided such individuals or entities remain in full compliance with those licenses. Sections 1, 2, 6, 7, 8, 9, 10 and 11 will survive any termination of this License.

If You bring a copyright, trademark, patent or any other infringement claim against any contributor over infringements You claim are made by the Work, your License from such contributor to the Work ends automatically.

Subject to the above terms and conditions, this License is perpetual (for the duration of the applicable copyright in the Work). Notwithstanding the above, the Author reserves the right to release the Work under different license terms or to stop distributing the Work at any time; provided, however that any such election will not serve to withdraw this License (or any other license that has been, or is required to be, granted under the terms of this License), and this License will continue in full force and effect unless terminated as stated above.

Publisher. The parties hereby confirm that the Publisher shall not, under any circumstances, be responsible for and shall not have any liability in respect of the subject matter of this License. The Publisher makes no warranty whatsoever in connection with the Work and shall not be liable to You or any party on any legal theory for any damages whatsoever, including without limitation any general, special, incidental or consequential damages arising in connection to this license. The Publisher reserves the right to cease making the Work available to You at any time without notice

Miscellaneous

This License shall be governed by the laws of the location of the head office of the Author or if the Author is an individual, the laws of location of the principal place of residence of the Author.

If any provision of this License is invalid or unenforceable under applicable law, it shall not affect the validity or enforceability of the remainder of the terms of this License, and without further action by the parties to this License, such provision shall be reformed to the minimum extent necessary to make such provision valid and enforceable.

No term or provision of this License shall be deemed waived and no breach consented to unless such waiver or consent shall be in writing and signed by the party to be charged with such waiver or consent.

This License constitutes the entire agreement between the parties with respect to the Work licensed herein. There are no understandings, agreements or representations with respect to the Work not specified herein. The Author shall not be bound by any additional provisions that may appear in any communication from You. This License may not be modified without the mutual written agreement of the Author and You

libogg

<http://www.xiph.org/ogg/>

Copyright (c) 2002, Xiph.org Foundation

Redistribution and use in source and binary forms, with or without modification, are permitted provided that the following conditions are met:

Redistributions of source code must retain the above copyright notice, this list of conditions and the following disclaimer.

Redistributions in binary form must reproduce the above copyright notice, this list of conditions and the following disclaimer in the documentation and/or other materials provided with the distribution.

Neither the name of the Xiph.org Foundation nor the names of its contributors may be used to endorse or promote products derived from this software without specific prior written permission.

THIS SOFTWARE IS PROVIDED BY THE COPYRIGHT HOLDERS AND CONTRIBUTORS "AS IS" AND ANY EXPRESS OR IMPLIED WARRANTIES, INCLUDING, BUT NOT LIMITED TO, THE IMPLIED WARRANTIES OF MERCHANTABILITY AND FITNESS FOR A PARTICULAR PURPOSE ARE DISCLAIMED. IN NO EVENT SHALL THE FOUNDATION OR CONTRIBUTORS BE LIABLE FOR ANY DIRECT, INDIRECT, INCIDENTAL, SPECIAL, EXEMPLARY, OR CONSEQUENTIAL DAMAGES (INCLUDING, BUT NOT LIMITED TO, PROCUREMENT OF SUBSTITUTE GOODS OR SERVICES; LOSS OF USE, DATA, OR PROFITS; OR BUSINESS INTERRUPTION) HOWEVER CAUSED AND ON ANY THEORY OF LIABILITY, WHETHER IN CONTRACT, STRICT LIABILITY, OR TORT (INCLUDING NEGLIGENCE OR OTHERWISE) ARISING IN ANY WAY OUT OF THE USE OF THIS

SOFTWARE, EVEN IF ADVISED OF THE POSSIBILITY OF SUCH DAMAGE.

libvorbis

<http://www.xiph.org/vorbis/>

Copyright (c) 2002-2004 Xiph.org Foundation

Redistribution and use in source and binary forms, with or without modification, are permitted provided that the following conditions are met:

Redistributions of source code must retain the above copyright notice, this list of conditions and the following disclaimer.

Redistributions in binary form must reproduce the above copyright notice, this list of conditions and the following disclaimer in the documentation and/or other materials provided with the distribution.

Neither the name of the Xiph.org Foundation nor the names of its contributors may be used to endorse or promote products derived from this software without specific prior written permission.

THIS SOFTWARE IS PROVIDED BY THE COPYRIGHT HOLDERS AND CONTRIBUTORS "AS IS" AND ANY EXPRESS OR IMPLIED WARRANTIES, INCLUDING, BUT NOT LIMITED TO, THE IMPLIED WARRANTIES OF MERCHANTABILITY AND FITNESS FOR A PARTICULAR PURPOSE ARE DISCLAIMED. IN NO EVENT SHALL THE FOUNDATION OR CONTRIBUTORS BE LIABLE FOR ANY DIRECT, INDIRECT, INCIDENTAL, SPECIAL, EXEMPLARY, OR CONSEQUENTIAL DAMAGES (INCLUDING, BUT NOT LIMITED TO, PROCUREMENT OF SUBSTITUTE GOODS OR SERVICES; LOSS OF USE, DATA, OR PROFITS; OR BUSINESS INTERRUPTION) HOWEVER CAUSED AND ON ANY THEORY OF LIABILITY, WHETHER IN CONTRACT, STRICT LIABILITY, OR TORT (INCLUDING NEGLIGENCE OR OTHERWISE) ARISING IN ANY WAY OUT OF THE USE OF THIS SOFTWARE, EVEN IF ADVISED OF THE POSSIBILITY OF SUCH DAMAGE.

Tremolo

<http://wss.co.uk/pinknoise/tremolo>

Copyright (C) 2002-2009 Xiph.org Foundation Changes Copyright (C) 2009-2010 Robin Watts for Pinknoise Productions Ltd

Redistribution and use in source and binary forms, with or without modification, are permitted provided that the following conditions are met:

- Redistributions of source code must retain the above copyright notice, this list of conditions and the following disclaimer.
- Redistributions in binary form must reproduce the above copyright notice, this list of conditions and the following disclaimer in the documentation and/or other materials provided with the distribution.
- Neither the name of the Xiph.org Foundation nor the names of its contributors may be used to endorse or promote products derived from this software without specific prior written permission.

THIS SOFTWARE IS PROVIDED BY THE COPYRIGHT HOLDERS AND CONTRIBUTORS "AS IS" AND ANY EXPRESS OR IMPLIED WARRANTIES, INCLUDING, BUT NOT LIMITED TO, THE IMPLIED WARRANTIES OF MERCHANTABILITY AND FITNESS FOR A PARTICULAR PURPOSE ARE DISCLAIMED. IN NO EVENT SHALL THE FOUNDATION OR CONTRIBUTORS BE LIABLE FOR ANY DIRECT, INDIRECT, INCIDENTAL, SPECIAL, EXEMPLARY, OR CONSEQUENTIAL DAMAGES (INCLUDING, BUT NOT LIMITED TO, PROCUREMENT OF SUBSTITUTE GOODS OR SERVICES; LOSS OF USE, DATA, OR PROFITS; OR BUSINESS INTERRUPTION) HOWEVER CAUSED AND ON ANY THEORY OF LIABILITY, WHETHER IN CONTRACT, STRICT LIABILITY, OR TORT (INCLUDING NEGLIGENCE OR OTHERWISE) ARISING IN ANY WAY OUT OF THE USE OF THIS SOFTWARE, EVEN IF ADVISED OF THE POSSIBILITY OF SUCH DAMAGE.

Tremor

<http://wiki.xiph.org/index.php/Tremor>

Copyright (c) 2002, Xiph.org Foundation

Redistribution and use in source and binary forms, with or without modification, are permitted provided that the following conditions are met:

- Redistributions of source code must retain the above copyright notice, this list of conditions and the following disclaimer.
- Redistributions in binary form must reproduce the above copyright notice, this list of conditions and the following disclaimer in the documentation and/or other materials provided with the distribution.
- Neither the name of the Xiph.org Foundation nor the names of its contributors may be used to endorse or promote products derived from this software without specific prior written permission.

THIS SOFTWARE IS PROVIDED BY THE COPYRIGHT HOLDERS AND CONTRIBUTORS "AS IS" AND ANY EXPRESS OR IMPLIED WARRANTIES, INCLUDING, BUT NOT LIMITED TO, THE IMPLIED WARRANTIES OF MERCHANTABILITY AND FITNESS FOR A PARTICULAR PURPOSE ARE DISCLAIMED. IN NO EVENT SHALL THE FOUNDATION OR CONTRIBUTORS BE LIABLE FOR ANY DIRECT, INDIRECT, INCIDENTAL, SPECIAL, EXEMPLARY, OR CONSEQUENTIAL DAMAGES (INCLUDING, BUT NOT LIMITED TO, PROCUREMENT OF SUBSTITUTE GOODS OR SERVICES; LOSS OF USE, DATA, OR PROFITS; OR BUSINESS INTERRUPTION) HOWEVER CAUSED AND ON ANY THEORY OF LIABILITY, WHETHER IN CONTRACT, STRICT LIABILITY, OR TORT (INCLUDING NEGLIGENCE OR OTHERWISE) ARISING IN ANY WAY OUT OF THE USE OF THIS SOFTWARE, EVEN IF ADVISED OF THE POSSIBILITY OF SUCH DAMAGE.

Mersenne Twister

<http://www.math.sci.hiroshima-u.ac.jp/~m-mat/MT/MT2002/CODES/mt19937ar.c>

Copyright (C) 1997 - 2002, Makoto Matsumoto and Takuji Nishimura, All rights reserved.

Redistribution and use in source and binary forms, with or without modification, are permitted provided that the following conditions are met:

Redistributions of source code must retain the above copyright notice, this list of conditions and the following disclaimer. Redistributions in binary form must reproduce the above copyright notice, this list of conditions and the following disclaimer in the documentation and/or other materials provided with the distribution.

The names of its contributors may not be used to endorse or promote products derived from this software without specific prior written permission.

THIS SOFTWARE IS PROVIDED BY THE COPYRIGHT HOLDERS AND CONTRIBUTORS "AS IS" AND ANY EXPRESS OR IMPLIED WARRANTIES, INCLUDING, BUT NOT LIMITED TO, THE IMPLIED WARRANTIES OF MERCHANTABILITY AND FITNESS FOR A PARTICULAR PURPOSE ARE DISCLAIMED. IN NO EVENT SHALL THE COPYRIGHT OWNER OR CONTRIBUTORS BE LIABLE FOR ANY DIRECT, INDIRECT, INCIDENTAL, SPECIAL, EXEMPLARY, OR CONSEQUENTIAL DAMAGES (INCLUDING, BUT NOT LIMITED TO, PROCUREMENT OF SUBSTITUTE GOODS OR SERVICES; LOSS OF USE, DATA, OR PROFITS; OR BUSINESS INTERRUPTION) HOWEVER CAUSED AND ON ANY THEORY OF LIABILITY, WHETHER IN CONTRACT, STRICT LIABILITY, OR TORT (INCLUDING NEGLIGENCE OR OTHERWISE) ARISING IN ANY WAY OUT OF THE USE OF THIS SOFTWARE, EVEN IF ADVISED OF THE POSSIBILITY OF SUCH DAMAGE.

zlib

<http://www.zlib.net/>

zlib.h -- interface of the 'zlib' general purpose compression library version 1.2.3, July 18th, 2005

Copyright (C) 1995-2004 Jean-loup Gailly and Mark Adler

This software is provided 'as-is', without any express or implied warranty. In no event will the authors be held liable for any damages arising from the use of this software.

Permission is granted to anyone to use this software for any purpose, including commercial applications, and to alter it and redistribute it freely, subject to the following restrictions:

The origin of this software must not be misrepresented; you must not claim that you wrote the original software. If you use this software in a product, an acknowledgment in the product documentation would be appreciated but is not required.

Altered source versions must be plainly marked as such, and must not be misrepresented as being the original software. This notice may not be removed or altered from any source distribution.

Jean-loup Gailly jloup@gzip.org, Mark Adler madler@alumni.caltech.edu

cURL

<http://curl.haxx.se>

COPYRIGHT AND PERMISSION NOTICE

Copyright (c) 1996 - 2011, Daniel Stenberg, <daniel@haxx.se>.

All rights reserved.

Permission to use, copy, modify, and distribute this software for any purpose with or without fee is hereby granted, provided that the above copyright notice and this permission notice appear in all copies.

THE SOFTWARE IS PROVIDED "AS IS", WITHOUT WARRANTY OF ANY KIND, EXPRESS OR IMPLIED, INCLUDING BUT NOT LIMITED TO THE WARRANTIES OF MERCHANTABILITY, FITNESS FOR A PARTICULAR PURPOSE AND NONINFRINGEMENT OF THIRD PARTY RIGHTS. IN NO EVENT SHALL THE AUTHORS OR COPYRIGHT HOLDERS BE LIABLE FOR ANY CLAIM, DAMAGES OR OTHER LIABILITY, WHETHER IN AN ACTION OF CONTRACT, TORT OR OTHERWISE, ARISING FROM, OUT OF OR IN CONNECTION WITH THE SOFTWARE OR THE USE OR OTHER DEALINGS IN THE SOFTWARE.

Except as contained in this notice, the name of a copyright holder shall not be used in advertising or otherwise to promote the sale, use or other dealings in this Software without prior written authorization of the copyright holder.

c-ares

<http://c-ares.haxx.se>

Copyright 1998 by the Massachusetts Institute of Technology.

Permission to use, copy, modify, and distribute this software and its documentation for any purpose and without fee is hereby granted, provided that the above copyright notice appear in all copies and that both that copyright notice and this permission notice appear in supporting documentation, and that the name of M.I.T. not be used in advertising or publicity pertaining to distribution of the software without specific, written prior permission. M.I.T. makes no representations about the suitability of this software for any purpose. It is provided "as is" without express or implied warranty.

Notes on use

4-488-938-11(1)

Copyright 2014 Sony Corporation



MULTI CHANNEL AV RECEIVER
STR-DN1050/STR-DN850

PROTECTOR

The receiver will automatically turn off after a few seconds. Check the followings:

- There may be an electrical surge or power failure. Unplug the AC power cord (mains lead) and then plug in the cord again after 30 minutes.
- The receiver is covered and the ventilation holes are blocked. Remove the object covering the ventilation holes of the receiver.
- The impedance of the connected speakers is below the rated impedance range indicated on the back panel of the receiver. Reduce the volume level.
- Unplug the AC power cord (mains lead) and let the receiver cool down for 30 minutes while performing the following troubleshooting:
 - Disconnect all of the speakers and subwoofer.
 - Check that the speaker wires are tightly twisted on both ends.
 - Connect the front speaker first, increase the volume level and operate the receiver for at least 30 minutes until it completely warms up. Then, connect each additional speaker one by one and test each additional speaker until you detect which speaker is causing the protection error.

After checking the above items and fixing any problems, plug in the AC power cord (mains lead) and turn on the receiver. If the problem persists, consult your nearest Sony dealer.

[Notes on use](#)

4-488-938-11(1)

Copyright 2014 Sony Corporation



MULTI CHANNEL AV RECEIVER
STR-DN1050/STR-DN850

USB FAIL

An over-current from the ψ (USB) port was detected. The receiver will automatically turn off after a few seconds. Check the iPhone/iPod or USB device, then unplug it and turn on the power again.

[Notes on use](#)

4-488-938-11(1)

Copyright 2014 Sony Corporation



MULTI CHANNEL AV RECEIVER
STR-DN1050/STR-DN850

List of messages after Auto Calibration measurements

- Code 30:
Headphones are connected to the PHONES jack on the receiver. Remove the headphones and perform the Auto Calibration again.
- Code 31:
Front speakers are not selected properly. Select the front speakers using SPEAKERS and perform the Auto Calibration again. For details on selecting the front speakers, see “[Selecting the front speakers.](#)”
- Code 32, Code 33:
 - Speakers were not detected or not connected properly.
 - None of the front speakers are connected or only one front speaker is connected.
 - Either the surround left or surround right speaker is not connected.
 - A surround back speaker is connected only to the SPEAKERS SURROUND BACK/BI-AMP/FRONT HIGH/FRONT B R terminal. If connecting only one surround back speaker, connect it to the SPEAKERS SURROUND BACK/BI-AMP/FRONT HIGH/FRONT B L terminal.
 - Either the front high left or front high right speaker is not connected.

The optimizer microphone is not connected. Make sure that the optimizer microphone is connected properly and perform the Auto Calibration again.

If the optimizer microphone is connected properly but the error code still appears, the optimizer microphone cable may be damaged.
- Warning 40:
The measurement process has been completed and a high noise level has been detected. You may be able to achieve better results if you try the process again in a quiet environment.
- Warning 41, Warning 42:
The input from the microphone is too large.
 - The distance between the speaker and the microphone may be too small. Set them further apart and perform the measurement again.
- Warning 43:
The distance and position of a subwoofer cannot be detected. This may be caused by noise. Try performing the measurement in a quiet environment.
- NO WARNING:
There is no warning information.

[Notes on use](#)

4-488-938-11(1)

Copyright 2014 Sony Corporation



MULTI CHANNEL AV RECEIVER
STR-DN1050/STR-DN850

iPhone/iPod message list

- Reading:
The receiver is recognizing and reading the information of the iPhone or iPod.
- Not supported:
An incompatible iPhone or iPod is connected.
- No device is connected:
No iPhone or iPod is connected.
- No Track:
No track was found.
- Headphone is not supported:
No sound is output from the headphones when an iPhone or iPod is connected.

[Notes on use](#)

4-488-938-11(1)

Copyright 2014 Sony Corporation



MULTI CHANNEL AV RECEIVER
STR-DN1050/STR-DN850

USB message list

- **Reading:**
The receiver is recognizing and reading the information of the USB device.
- **Device error:**
The memory of the USB device could not be recognized.
- **Not supported:**
An incompatible USB device is connected, an unknown device is connected, or the USB device is connected through a USB hub.
- **No device is connected:**
No USB device is connected or the connected USB device is not recognized.
- **Cannot get info:**
The number of audio files/folders/folder levels exceeds the limit for the number that the receiver can recognize.
- **Cannot play:**
The receiver cannot play the audio file due to an incompatible file format or playback restrictions.
- **Not in use:**
An operation that is currently prohibited has been attempted.
- **No Track:**
No track was found.

[Notes on use](#)

4-488-938-11(1)

Copyright 2014 Sony Corporation



MULTI CHANNEL AV RECEIVER
STR-DN1050/STR-DN850

The receiver is turned off automatically.

- [Auto Standby] is set to [On].
- The sleep timer function was activated.
- [PROTECTOR] was activated.

Related Topic

- [Setting standby mode \(Auto Standby\)](#)
- [Using the sleep timer](#)
- [PROTECTOR](#)

[Notes on use](#)

4-488-938-11(1)

Copyright 2014 Sony Corporation



MULTI CHANNEL AV RECEIVER
STR-DN1050/STR-DN850

No image appears on the TV.

- Select the appropriate input using the input buttons.
- Set your TV to the appropriate input mode.
- Move your audio device away from the TV.
- Assign the component video input correctly (for STR-DN1050 only).
- When you are upconverting input signals using the receiver, use the same type of output signals as input signals (for STR-DN1050 only).
- Make sure that cables are correctly and securely connected to devices.
- Some playback devices need to be set up. Refer to the operating instructions supplied with each device.
- Be sure to use a High Speed HDMI cable when you view images or listen to sound, especially for 1080p, Deep Color (Deep Colour), 4K or 3D transmission.
- The output of the HDMI video signals of the receiver may be set to [HDMI OFF]. In this case,
 - set to [HDMI ON] (for STR-DN850 only).
 - set to [HDMI A], [HDMI B], or [HDMI A + B] (for STR-DN1050 only).

[Notes on use](#)

4-488-938-11(1)

Copyright 2014 Sony Corporation



MULTI CHANNEL AV RECEIVER
STR-DN1050/STR-DN850

No 3D image appears on the TV.

- Depending on the TV or the video device, 3D images may not be displayed. Check the HDMI video formats supported by the receiver.
- Be sure to use a High Speed HDMI cable.

[Notes on use](#)

4-488-938-11(1)

Copyright 2014 Sony Corporation



MULTI CHANNEL AV RECEIVER
STR-DN1050/STR-DN850

No 4K image appears on the TV.

- Depending on the TV or the video device, 4K images may not be displayed. Check the video capability and settings of your TV and video device. Also, make sure you connect the video device to the 4K-compatible HDMI IN jack of this receiver.
- Be sure to use a High Speed HDMI cable.

[Notes on use](#)

4-488-938-11(1)

Copyright 2014 Sony Corporation



MULTI CHANNEL AV RECEIVER
STR-DN1050/STR-DN850

No image is output from the TV when the receiver is in standby mode.

- When the receiver enters standby mode, the image from the last HDMI device selected before you turned off the receiver is displayed. If you are enjoying content from another device, play the content on the device and perform the One-Touch Play operation, or turn on the receiver to select the HDMI device from which you want to enjoy content.
- Make sure [Pass Through] is set to [On] (For USA, Canadian, Mexican, and Australian models only) or [Auto] in the HDMI Settings menu.

Related Topic

- [Passing HDMI signals through \(Pass Through\)](#)

[Notes on use](#)

4-488-938-11(1)

Copyright 2014 Sony Corporation



MULTI CHANNEL AV RECEIVER
STR-DN1050/STR-DN850

The GUI menu does not appear on the TV screen.

- GUI is only available when you connect the TV to the HDMI OUT A (*1), HDMI OUT B (*1) or HDMI TV OUT (*2) jack.
- Press HOME to turn the GUI on.
- Check that the TV is connected correctly.
- Depending on the TV, the GUI menu may take some time to appear on the TV screen.

*1 For STR-DN1050 only

*2 For STR-DN850 only

Notes on use

4-488-938-11(1)

Copyright 2014 Sony Corporation



MULTI CHANNEL AV RECEIVER
STR-DN1050/STR-DN850

The display panel is turned off.

- If the PURE DIRECT indicator on the front panel lights up, press PURE DIRECT to turn off this function.
- Press DIMMER on the receiver to adjust the brightness of the display panel.

[Notes on use](#)

4-488-938-11(1)

Copyright 2014 Sony Corporation



MULTI CHANNEL AV RECEIVER
STR-DN1050/STR-DN850

No sound or only a very low level of sound is heard, no matter which device is selected.

- Check that all connecting cables are inserted to their input/output jacks on the receiver, speakers and the devices.
- Check that the receiver and all devices are turned on.
- Check that MASTER VOLUME on the receiver is not set to [VOL MIN].
- Check that SPEAKERS on the receiver is not set to [SPK OFF].
- Check that headphones are not connected to the receiver.
- Press  to cancel the muting function.
- Try pressing the input button on the remote control or turning INPUT SELECTOR on the receiver to select the device of your choice.
- If you want to listen to sound from the TV speaker, set [Audio Out] to [TV+AMP] in the HDMI Settings menu. If you cannot play multi-channel audio source, set [AMP]. However, the sound will not be output through the TV speaker.
- Sound may be interrupted when the sampling frequency, number of channels or audio format of audio output signals from the playback device is switched.

Notes on use

4-488-938-11(1)

Copyright 2014 Sony Corporation



MULTI CHANNEL AV RECEIVER
STR-DN1050/STR-DN850

There is severe humming or noise.

- Check that the speakers and device are connected securely.
- Check that the connecting cables are not near a transformer or motor, and are at least 3 meters (10 feet) away from a TV set or fluorescent light.
- Move your audio device away from the TV.
- The plugs and jacks are dirty. Wipe them with a cloth slightly moistened with alcohol.

[Notes on use](#)

4-488-938-11(1)

Copyright 2014 Sony Corporation



MULTI CHANNEL AV RECEIVER
STR-DN1050/STR-DN850

No sound or only a very low level of sound is heard from specific speakers.

- Connect a pair of headphones to the PHONES jack to verify that sound is output from the headphones. If only one channel is output from the headphones, the device may not be connected to the receiver correctly. Check that all of the cables are fully inserted into the jacks on both the receiver and the device.
If both channels are output from the headphones, the front speaker may not be connected to the receiver correctly. Check the connection of the front speaker that is not outputting any sound.
- Make sure you have connected to both the L and R jacks of an analog device, as analog devices require both L and R jack connections. Use an audio cable (not supplied).
- Adjust the speaker level.
- Check that the speaker settings are appropriate for the setup using [Auto Calibration] or [Speaker Connection] in the Speaker Settings menu. Then check that sound is output from each speaker correctly using [Test Tone] in the Speaker Settings menu.
- Some discs have no Dolby Digital Surround EX information. In this case, sound may not be output from some speakers.
- Check that the subwoofer is connected correctly and securely.
- Make sure you have turned on your subwoofer.
- Depending on the selected sound field, sound may not be available from the subwoofer.
- There is no sound from the subwoofer when all speakers are set to [Large] and [Neo:6 Cinema] or [Neo:6 Music] is selected.

[Notes on use](#)

4-488-938-11(1)

Copyright 2014 Sony Corporation



MULTI CHANNEL AV RECEIVER
STR-DN1050/STR-DN850

There is no sound from a specific device.

- Check that the device is correctly connected to the corresponding audio input jacks.
- Check that the cable(s) used for the connection is (are) fully inserted into the jacks on both the receiver and the device.
- Check the Input Mode setting.
- Check that the device is correctly connected to the corresponding HDMI jack.
- The HDMI settings of some playback devices need to be configured. Refer to the operating instructions supplied with each device.
- Be sure to use a High Speed HDMI cable when you view images or listen to sound, especially for 1080p, Deep Color (Deep Colour), 4K or 3D transmission.
- Sound may not be output from the receiver while the GUI appears on the TV screen. Press HOME to turn the GUI off.
- Audio signals (format, sampling frequency, bit length, etc.) transmitted from an HDMI jack may be suppressed by the connected device. Check the setup of a device connected via an HDMI cable if the image is poor or the sound does not come out of the device.
- When a connected device does not support the copyright protection technology (HDCP), the image and/or the sound from the HDMI OUT jack may be distorted or may not be output. If this is the case, check the specifications of the connected device.
- Set the image resolution of the playback device to more than 720p/1080i to enjoy High Bitrate Audio (DTS-HD Master Audio, Dolby TrueHD).
- The image resolution of the playback device may need to be configured to certain settings before you can enjoy DSD and Multi Channel Linear PCM. Refer to the operating instructions of the playback device.
- Make sure the TV supports the System Audio Control function.
- If the TV does not have a System Audio Control function, set [Audio Out] in the HDMI Settings menu to:
 - [TV+AMP] if you want to listen to the sound from the TV speaker and receiver.
 - [AMP] if you want to listen to the sound from the receiver only.
- When you connect the receiver to a video device (projector, etc.), sound may not be output from the receiver. In this case, set [Audio Out] to [AMP] in the HDMI Settings menu.
- You cannot listen to the sound of a device connected to the receiver while TV input is selected on the receiver.
 - Be sure to change the input of the receiver to HDMI if you want to watch a program on a device connected via HDMI connection to the receiver.
 - Change the TV channel if you want to watch a TV broadcast.
 - Be sure to select the correct device or input when watching a program from a device connected to the TV. Refer to the section on this operation in the operating instructions of the TV.
- When [2ch Analog Direct] is being used, sound is not output. Use another sound field.
- When using the Control for HDMI function, you cannot control connected devices using the remote control of the TV.
 - Some devices and TVs need to be set up. Refer to the operating instructions supplied with each device and TV.
 - Change the input of the receiver to the HDMI input connected to the device.

- Check that the selected digital audio input jack is not assigned to another input.

Notes on use

4-488-938-11(1)

Copyright 2014 Sony Corporation



MULTI CHANNEL AV RECEIVER
STR-DN1050/STR-DN850

The left and right sound is unbalanced or reversed.

- Check that the speakers and device are connected correctly and securely.
- Adjust the sound level parameters using the Speaker Settings menu.

[Notes on use](#)

4-488-938-11(1)

Copyright 2014 Sony Corporation



MULTI CHANNEL AV RECEIVER
STR-DN1050/STR-DN850

Dolby Digital or DTS multi-channel sound is not reproduced.

- Check that the DVD, etc. you are playing is recorded in Dolby Digital or DTS format.
- When connecting the DVD player, etc., to the digital input jacks of this receiver, make sure the digital audio output setting of the connected device is available.
- Set [Audio Out] to [AMP] in the HDMI Settings menu.
- You can only enjoy High Bitrate Audio (DTS-HD Master Audio, Dolby TrueHD), DSD and Multi Channel Linear PCM with an HDMI connection.

[Notes on use](#)

4-488-938-11(1)

Copyright 2014 Sony Corporation



MULTI CHANNEL AV RECEIVER
STR-DN1050/STR-DN850

The surround effect cannot be obtained.

- Make sure you have selected a sound field for movies or music.
- [PLII Movie], [PLII Music], [PLIIX Movie], [PLIIX Music], [Neo:6 Cinema] and [Neo:6 Music] do not work when the speaker pattern is set to 2/0 or 2/0.1.

[Notes on use](#)

4-488-938-11(1)

Copyright 2014 Sony Corporation



MULTI CHANNEL AV RECEIVER
STR-DN1050/STR-DN850

A test tone is not output from the speakers.

- The speaker cables may not be connected securely. Check that they are connected securely and cannot be disconnected by pulling on them slightly.
- The speaker cables may have short-circuited.

[Notes on use](#)

4-488-938-11(1)

Copyright 2014 Sony Corporation



MULTI CHANNEL AV RECEIVER
STR-DN1050/STR-DN850

A test tone is output from a different speaker than the speaker displayed on the TV screen.

- The speaker pattern setup is incorrect. Make sure that the speaker connections and the speaker pattern match correctly.

[Notes on use](#)

4-488-938-11(1)

Copyright 2014 Sony Corporation



MULTI CHANNEL AV RECEIVER
STR-DN1050/STR-DN850

No sound is output from the TV when the receiver is in standby mode.

- When the receiver enters standby mode, sound is output from the last HDMI device selected before you turned off the receiver. If you are enjoying content from another device, play the content on the device and perform the One-Touch Play operation, or turn on the receiver to select the HDMI device from which you want to enjoy content.
- Make sure [Pass Through] is set to [On] (For USA, Canadian, Mexican, and Australian models only) or [Auto] in the HDMI Settings menu.

Related Topic

- [Passing HDMI signals through \(Pass Through\)](#)

[Notes on use](#)

4-488-938-11(1)

Copyright 2014 Sony Corporation

MULTI CHANNEL AV RECEIVER
STR-DN1050/STR-DN850

The FM reception is poor.

- Use a 75-ohm coaxial cable (not supplied) to connect the receiver to an outdoor FM antennas (aerial) as shown below.

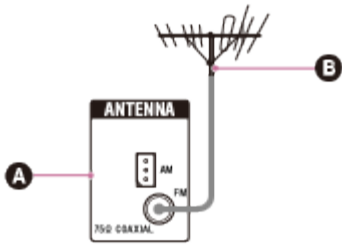

- A Receiver
- B Outdoor FM antenna (aerial)

Related Topic

- [The FM stereo reception is poor.](#)

Notes on use

4-488-938-11(1)

Copyright 2014 Sony Corporation



MULTI CHANNEL AV RECEIVER
STR-DN1050/STR-DN850

The FM stereo reception is poor.

Perform the following procedure:

1. Select [Listen] - [FM TUNER] from the home menu.
2. Select a station on the FM band.
3. Press OPTIONS.
4. Select [STEREO/MONO] from the menu.
5. Select [MONO].

Note

- You can set FM mode in the options menu if the frequency indication is selected in step 3.

[Notes on use](#)

4-488-938-11(1)

Copyright 2014 Sony Corporation



MULTI CHANNEL AV RECEIVER
STR-DN1050/STR-DN850

You cannot tune to radio stations.

- Check that the antennas (aerials) are connected securely. Adjust the antennas (aerials) and connect an external antenna (aerial) if necessary.
- The signal of the stations is too weak with automatic tuning. Use direct tuning.
- Make sure you set the tuning scale correctly (when tuning to AM stations with direct tuning).
- No stations have been preset or the preset stations have been cleared (when tuning by scanning preset stations is used). Preset the stations.
- Press DISPLAY repeatedly on the remote control so that the frequency appears on the display panel.

[Notes on use](#)

4-488-938-11(1)

Copyright 2014 Sony Corporation



MULTI CHANNEL AV RECEIVER
STR-DN1050/STR-DN850

RDS does not work (for European and Australian models only).

- Make sure that you are tuned to an FM RDS station.
- Select a stronger FM station.
- The station you tuned to is not transmitting the RDS signal or the signal is weak.

[Notes on use](#)

4-488-938-11(1)

Copyright 2014 Sony Corporation



MULTI CHANNEL AV RECEIVER
STR-DN1050/STR-DN850

The RDS information that you want does not appear (for European and Australian models only).

- The service may be temporarily out of order. Contact the radio station and find out whether they actually provide the service in question.

[Notes on use](#)

4-488-938-11(1)

Copyright 2014 Sony Corporation



MULTI CHANNEL AV RECEIVER
STR-DN1050/STR-DN850

The sound is distorted.

- Press  - on the remote control repeatedly. You can also use MASTER VOLUME on the receiver.

[Notes on use](#)

4-488-938-11(1)

Copyright 2014 Sony Corporation



MULTI CHANNEL AV RECEIVER
STR-DN1050/STR-DN850

There is no sound from an iPhone/iPod.

- Disconnect the iPhone/iPod and connect it again.

[Notes on use](#)

4-488-938-11(1)

Copyright 2014 Sony Corporation



MULTI CHANNEL AV RECEIVER
STR-DN1050/STR-DN850

An iPhone/iPod cannot be charged.

- Check that the receiver is turned on.
- Make sure the iPhone/iPod is connected securely.

[Notes on use](#)

4-488-938-11(1)

Copyright 2014 Sony Corporation



MULTI CHANNEL AV RECEIVER
STR-DN1050/STR-DN850

An iPhone/iPod cannot be operated.

- Depending on the content of the iPhone/iPod, it may take time to start playback.
- Turn off the receiver, then disconnect the iPhone/iPod. Turn on the receiver again and reconnect the iPhone/iPod.
- You are using an incompatible iPhone/iPod. See “[Compatible iPhone/iPod/iPad models](#)” for the compatible device types.

[Notes on use](#)

4-488-938-11(1)

Copyright 2014 Sony Corporation



MULTI CHANNEL AV RECEIVER
STR-DN1050/STR-DN850

The ringtone volume of an iPhone does not change.

- Adjust the ring volume using the controls on the iPhone.

[Notes on use](#)

4-488-938-11(1)

Copyright 2014 Sony Corporation



MULTI CHANNEL AV RECEIVER
STR-DN1050/STR-DN850

Are you using a compatible USB device?

- If you connect an incompatible USB device, the following problems may occur. See “[Compatible USB devices and USB specifications](#)” for the compatible device types.
 - The USB device is not recognized.
 - File or folder names are not displayed on this receiver.
 - Playback is not possible.
 - The sound skips.
 - There is noise.
 - Distorted sound is output.

[Notes on use](#)

4-488-938-11(1)

Copyright 2014 Sony Corporation



MULTI CHANNEL AV RECEIVER
STR-DN1050/STR-DN850

There is noise, skipping, or distorted sound.

- Turn off the receiver, reconnect the USB device, and then turn on the receiver.
- The music data itself contains noise, or the sound is distorted.

[Notes on use](#)

4-488-938-11(1)

Copyright 2014 Sony Corporation



MULTI CHANNEL AV RECEIVER
STR-DN1050/STR-DN850

A USB device is not recognized.

- Turn off the receiver, then disconnect the USB device. Turn on the receiver again and reconnect the USB device.
- Connect a compatible USB device.
- The USB device does not work properly. Refer to the section on how to deal with this problem in the operating instructions of the USB device.

[Notes on use](#)

4-488-938-11(1)

Copyright 2014 Sony Corporation



MULTI CHANNEL AV RECEIVER
STR-DN1050/STR-DN850

Playback does not start.

- Turn off the receiver, reconnect the USB device, and then turn on the receiver.
- Connect a compatible USB device.
- Select [USB] and select a folder/track, then press ►|| to start playback.

[Notes on use](#)

4-488-938-11(1)

Copyright 2014 Sony Corporation



MULTI CHANNEL AV RECEIVER
STR-DN1050/STR-DN850

A USB device cannot be connected to the USB port.

- The USB device is being connected upside down. Connect the USB device in the correct orientation.

[Notes on use](#)

4-488-938-11(1)

Copyright 2014 Sony Corporation



MULTI CHANNEL AV RECEIVER
STR-DN1050/STR-DN850

Erroneous display.

- The data stored in the USB device may have been corrupted.
- The character codes that can be displayed by this receiver are as follows:
 - Upper case letters (A to Z)
 - Lower case letters (a to z)
 - Numbers (0 to 9)
 - Symbols (' = < > * + , - . / @ [\] _ `)

Other characters may not be displayed correctly.

[Notes on use](#)

4-488-938-11(1)

Copyright 2014 Sony Corporation



MULTI CHANNEL AV RECEIVER
STR-DN1050/STR-DN850

[Reading] is displayed for an extended time, or it takes a long time before playback starts.

- The reading process can take a long time in the following cases:
 - There are many folders or files on the USB device.
 - The file structure is extremely complex.
 - The memory capacity is excessive.
 - The internal memory is fragmented.

We therefore recommend following these guidelines:

- Total folders on USB device: 256 or less (including [ROOT] folder)
- Total files per folder: 256 or less.

[Notes on use](#)

4-488-938-11(1)

Copyright 2014 Sony Corporation



MULTI CHANNEL AV RECEIVER
STR-DN1050/STR-DN850

An audio file cannot be played.

- MP3 files in MP3 PRO format cannot be played.
- The audio file is a multiple track audio file.
- Some AAC files may not be played correctly.
- WMA files in Windows Media Audio Lossless and Professional formats cannot be played.
- USB devices formatted with file systems other than FAT16 or FAT32 are unsupported (*).
- If you use a partitioned USB device, only audio files on the first partition can be played.
- Playback is possible up to eight levels (including the [ROOT] folder).
- There are more than 256 folders (including the [ROOT] folder).
- There are more than 256 files.
- Files that are encrypted, protected by passwords, etc. cannot be played.

* The receiver supports FAT16 and FAT32, but some USB devices may not support these FAT systems. For details, refer to the operating instructions of each USB device or contact the manufacturer.

[Notes on use](#)

4-488-938-11(1)

Copyright 2014 Sony Corporation



MULTI CHANNEL AV RECEIVER
STR-DN1050/STR-DN850

Cannot connect to the network using WPS via a wireless LAN connection.

- You cannot connect to a network using WPS if your access point is set to WEP. Set up your network after searching the access point using the access point scan.

[Notes on use](#)

4-488-938-11(1)

Copyright 2014 Sony Corporation



MULTI CHANNEL AV RECEIVER
STR-DN1050/STR-DN850

An error message appears.

- Check the nature of the error. See “[Network features message list.](#)”

[Notes on use](#)

4-488-938-11(1)

Copyright 2014 Sony Corporation



MULTI CHANNEL AV RECEIVER
STR-DN1050/STR-DN850

Cannot connect to the network.

- Check that the LAN cable is connected to the receiver when you want to connect the receiver to the network via a wired LAN connection.
- Check that the LAN cable is disconnected from the receiver when you want to connect the receiver to the network via a wireless LAN connection.
- Check the network information. If [Not Connected] appears, set up the network connection again.
- If the system is connected through a wireless network, move the receiver and the wireless LAN router/access point closer to each other and perform the setup again.
 - Make sure that you use a wireless LAN router/access point.
 - Make sure that the wireless LAN router/access point is turned on.
 - Check the settings of the wireless LAN router/access point and perform the setup again. For details on the settings of devices, refer to the operating instructions of the devices.
 - Wireless networks are influenced by electromagnetic radiation emitted by microwave ovens and other devices. Move the receiver away from these devices.

Related Topic

● [Checking the network information \(Information\)](#)

[Notes on use](#)

4-488-938-11(1)

Copyright 2014 Sony Corporation



MULTI CHANNEL AV RECEIVER
STR-DN1050/STR-DN850

Cannot control the receiver using a TV SideView device.

- It may take some time for the receiver to connect to the network after you turn on the receiver. Wait for a few moments, and then try using TV SideView again.
- It may take some time for TV SideView to find the receiver that is connected to the network.
- The receiver may have been deleted from the TV SideView device. Delete the TV SideView device from the receiver and then re-register the devices.
- The TV SideView device may have been deleted from the receiver. Delete the receiver from the TV SideView device and then re-register the receiver.

Related Topic

- [Registering a TV SideView device to the receiver](#)

[Notes on use](#)

4-488-938-11(1)

Copyright 2014 Sony Corporation



MULTI CHANNEL AV RECEIVER
STR-DN1050/STR-DN850

Cannot select the Network Settings menu.

- Wait for a few moments after you have turned on the receiver, and then select the Network Settings menu again.

[Notes on use](#)

4-488-938-11(1)

Copyright 2014 Sony Corporation



MULTI CHANNEL AV RECEIVER
STR-DN1050/STR-DN850

Cannot connect to the network.

- Make sure the router or the wireless LAN router/access point is turned on.
- The network settings on the receiver may be incorrect.
If [Not Connected] appears on the [Information] screen, set up the network connection again.
- Confirm that the receiver is connected to the router or the wireless LAN router/access point correctly.
- If the system is connected to a wireless network, move the receiver and the wireless LAN router/access point closer to each other.
- If you have initialized the receiver or performed a system recovery on your server, perform the network settings again.

Related Topic

- [Checking the network information \(Information\)](#)

[Notes on use](#)

4-488-938-11(1)

Copyright 2014 Sony Corporation



MULTI CHANNEL AV RECEIVER
STR-DN1050/STR-DN850

A server does not appear in the server list. ([No server is available] appears on the TV screen.)

- You may have turned on this receiver before you turned on the server. Refresh the server list.
- Make sure that the router or the wireless LAN router/access point is turned on.
- The server may require some settings to accept the connection from the receiver. Confirm that the server has been configured correctly. Confirm that the receiver is allowed to receive music streamed from the server.
- Confirm that the receiver and the server are connected to the router or the wireless LAN router/access point correctly. Check the network settings information.
- Refer to the operating instructions of your router or wireless LAN router/access point and check the multicast setting. Try turning the multicast setting on or off on the wireless LAN router/access point.
- If your server is an software application on your PC, confirm the firewall setup and the security software settings.

[Notes on use](#)

4-488-938-11(1)

Copyright 2014 Sony Corporation



MULTI CHANNEL AV RECEIVER
STR-DN1050/STR-DN850

Playback does not start, or does not automatically proceed to the next track or file.

- Make sure that the audio file you are trying to play is in a format supported by this receiver.
- Audio content with DRM (Digital Rights Management) copyright protection cannot be played on this receiver.
- Make sure that “repeat one,” “repeat all,” and “shuffle” are configured correctly. Press OPTION, then select [Repeat] or [Shuffle] to set to the playback mode.

[Notes on use](#)

4-488-938-11(1)

Copyright 2014 Sony Corporation



MULTI CHANNEL AV RECEIVER
STR-DN1050/STR-DN850

The sound skips during playback.

- The bandwidth of your network may be too low. Check your router and the network environment.
- The bandwidth of your network may be too low. If using wireless LAN connection, move the receiver and the wireless LAN router/access point closer to each other, without any obstructions between them.
- The server may be busy. If using your computer as a server, the computer may be running too many applications. If anti-virus software is active on the computer, temporarily disable it as anti-virus software needs a large amount of system resources.
- Depending on the network environment, it may not be possible to play tracks with more than one device operating at the same time. Turn off other devices to enable the receiver to play tracks.

[Notes on use](#)

4-488-938-11(1)

Copyright 2014 Sony Corporation



MULTI CHANNEL AV RECEIVER
STR-DN1050/STR-DN850

[Cannot play] appears.

- You cannot play files other than audio files.
- The server may require some settings to accept the connection from the receiver. Confirm that the server has been configured correctly. Confirm that the receiver is allowed to receive music streamed from the server.
- Check to confirm whether audio files on the server have been damaged or erased. Refer to the operating instructions supplied with the server.
- You cannot play the following tracks:
 - Tracks that violate playback restrictions.
 - Tracks with copyright information.
 - Tracks that you have purchased at an online music store that does not allow home network streaming.
 - Tracks in formats unsupported by the receiver.
- Confirm that the selected track has not been erased from the server. If the track has been erased, select another track.
- Make sure that the router or the wireless LAN router/access point is turned on.
- The server may be unstable. Restart it.
- Confirm that the receiver and the server are connected to the router or the wireless LAN router/access point correctly.
- Audio content with DRM (Digital Rights Management) copyright protection cannot be played on this receiver.
- There may be some tracks that cannot be played on this receiver.

Related Topic

- [Compatible formats with DLNA](#)

[Notes on use](#)

4-488-938-11(1)

Copyright 2014 Sony Corporation



MULTI CHANNEL AV RECEIVER
STR-DN1050/STR-DN850

[No Track] appears.

- If there are no folders or files that can be played on the receiver in the selected folder, you cannot expand the folder to display its contents.

[Notes on use](#)

4-488-938-11(1)

Copyright 2014 Sony Corporation



MULTI CHANNEL AV RECEIVER
STR-DN1050/STR-DN850

Cannot play copyrighted files.

- Audio content with DRM (Digital Rights Management) copyright protection cannot be played on this receiver.

[Notes on use](#)

4-488-938-11(1)

Copyright 2014 Sony Corporation



MULTI CHANNEL AV RECEIVER
STR-DN1050/STR-DN850

Cannot select a previously selected track.

- The track information may have been changed on the server. Refresh the server list and then reselect the server.

[Notes on use](#)

4-488-938-11(1)

Copyright 2014 Sony Corporation



MULTI CHANNEL AV RECEIVER
STR-DN1050/STR-DN850

Controller devices or applications on the home network cannot connect to the receiver.

- Confirm that the network is correctly set up.
- The device is set to [Disable] on the device list, or is not added to the device list.
- A maximum of 20 connectable devices has been set. Delete unnecessary devices on the device list and then set [Allow All Controllers] to [On] or [Off].
- Server operation of the receiver is suspended if the receiver is conducting one of the following operations:
 - Playing a track stored on the server (the receiver is operating as a player)
 - Updating the software
 - Formatting the system
 - Changing the settings
- [External Control] is set to [Off]. Set it to [On] to control the receiver with “SongPal.”
- TV SideView is not registered. TV SideView Registration is required to control the receiver with TV SideView.

[Notes on use](#)

4-488-938-11(1)

Copyright 2014 Sony Corporation



MULTI CHANNEL AV RECEIVER
STR-DN1050/STR-DN850

The receiver cannot be turned on by devices on a network.

- The receiver itself does not support the Wake-on-LAN.
- Set [Network Standby] to [On] if you want to turn the receiver on by operating the devices on a network (for USA and Canadian models only).

[Notes on use](#)

4-488-938-11(1)

Copyright 2014 Sony Corporation



MULTI CHANNEL AV RECEIVER
STR-DN1050/STR-DN850

The receiver cannot be found from an iPhone/iPad/iPod or iTunes.

- Make sure the iPhone/iPad/iPod or computer with iTunes is connected to your home network.
- Update the software of the receiver and the iPhone/iPad/iPod or iTunes to the latest version.

[Notes on use](#)

4-488-938-11(1)

Copyright 2014 Sony Corporation



MULTI CHANNEL AV RECEIVER
STR-DN1050/STR-DN850

The sound skips.

- The sound may skip depending on factors such as the network environment. Depending on the audio files, playback may require network speed. If you use a wired LAN connection, check the network hub and/or router. If you use a wireless LAN connection, check the access point and/or router.

[Notes on use](#)

4-488-938-11(1)

Copyright 2014 Sony Corporation



MULTI CHANNEL AV RECEIVER
STR-DN1050/STR-DN850

The receiver cannot be operated.

- Update the software of the iPhone/iPad/iPod or iTunes to the latest version.
- Update the software of the receiver to the latest version.
- Connection between the AirPlay device and receiver may be lost. Restart the AirPlay device and/or the receiver.

[Notes on use](#)

4-488-938-11(1)

Copyright 2014 Sony Corporation



MULTI CHANNEL AV RECEIVER
STR-DN1050/STR-DN850

Cannot connect the receiver to a service.

- Make sure that the router or the wireless LAN router/access point is turned on.
- Check the network information. If [Not Connected] appears, set up the network connection again.
- If the system is connected to a wireless network, move the receiver and the wireless LAN router/access point closer to each other.
- If your contract with your Internet provider limits Internet connection to one device at a time, this device will not be able to access the Internet when another device is already connected. Consult your carrier or service provider.

Related Topic

- [Checking the network information \(Information\)](#)

[Notes on use](#)

4-488-938-11(1)

Copyright 2014 Sony Corporation



MULTI CHANNEL AV RECEIVER
STR-DN1050/STR-DN850

The sound skips.

- The bandwidth of your network may be too low. If using wireless LAN connection, move the receiver and the wireless LAN router/access point closer to each other, without any obstructions between them.

[Notes on use](#)

4-488-938-11(1)

Copyright 2014 Sony Corporation



MULTI CHANNEL AV RECEIVER
STR-DN1050/STR-DN850

Pairing cannot be done.

- Move the BLUETOOTH device closer to the receiver.
- Pairing may not be possible if there are other BLUETOOTH devices near the receiver. In this case, turn off the other BLUETOOTH devices.
- Correctly enter the same passkey that was entered on the BLUETOOTH device.

[Notes on use](#)

4-488-938-11(1)

Copyright 2014 Sony Corporation



MULTI CHANNEL AV RECEIVER
STR-DN1050/STR-DN850

Cannot make a BLUETOOTH connection.

- The BLUETOOTH device you attempted to connect does not support the A2DP profile, and cannot be connected with the receiver.
- Press BLUETOOTH on the receiver to connect to the last connected BLUETOOTH device.
- Turn on the BLUETOOTH function of the BLUETOOTH device.
- Establish a connection from the BLUETOOTH device.
- The pairing registration information has been erased. Perform the pairing operation again.
- While connected to a BLUETOOTH device, this receiver cannot be detected and a connection cannot be established from another BLUETOOTH device.
- Erase the pairing registration information of the BLUETOOTH device and perform the pairing operation again.

[Notes on use](#)

4-488-938-11(1)

Copyright 2014 Sony Corporation



MULTI CHANNEL AV RECEIVER
STR-DN1050/STR-DN850

The sound skips or fluctuates, or the connection is lost.

- The receiver and the BLUETOOTH device are too far apart.
- If there are obstructions between the receiver and your BLUETOOTH device, remove these or move the receiver and/or device avoid them.
- If there is a device that generates electromagnetic radiation, such as a wireless LAN, other BLUETOOTH device, or a microwave oven nearby, move it away.

[Notes on use](#)

4-488-938-11(1)

Copyright 2014 Sony Corporation



MULTI CHANNEL AV RECEIVER
STR-DN1050/STR-DN850

The sound of your BLUETOOTH device cannot be heard on the receiver.

- Turn up the volume on your BLUETOOTH device first, and then adjust the volume using  + (or MASTER VOLUME on the receiver).

[Notes on use](#)

4-488-938-11(1)

Copyright 2014 Sony Corporation



MULTI CHANNEL AV RECEIVER
STR-DN1050/STR-DN850

Severe humming or noise.

- If there are obstructions between the receiver and your BLUETOOTH device, remove them or move the receiver and/or device avoid them.
- If there is a device that generates electromagnetic radiation, such as a wireless LAN, other BLUETOOTH device, or a microwave oven nearby, move it away.
- Turn down the volume of the connected BLUETOOTH device.

[Notes on use](#)

4-488-938-11(1)

Copyright 2014 Sony Corporation



MULTI CHANNEL AV RECEIVER
STR-DN1050/STR-DN850

The Control for HDMI function does not work.

- Check the HDMI connection.
- Make sure [Control for HDMI] is set to [On] in the HDMI Settings menu.
- Make sure the connected device supports the Control for HDMI function.
- Check the Control for HDMI settings on the connected device. Refer to the operating instructions of the connected device.
- If you unplug the HDMI cable or change the connection, repeat the procedures of [“Preparing for “BRAVIA” Sync.”](#)
- When [Control for HDMI] is set to [Off], “BRAVIA” Sync does not work properly, even if the device is connected to the HDMI IN jack.
- The types and number of devices that can be controlled by the “BRAVIA” Sync feature are restricted by the HDMI CEC standard as follows:
 - Recording devices (Blu-ray Disc recorders, DVD recorders, etc.): up to 3 devices
 - Playback devices (Blu-ray Disc players, DVD players, etc.): up to 3 devices
 - Tuner-related devices: up to 4 devices (the receiver uses one of them for its GUI operations.)
 - AV receivers (audio systems): up to 1 device
- Make sure your TV is connected to the HDMI OUT A jack of the receiver (for STR-DN1050 only).
- Make sure the HDMI OUTPUT setting is set to [HDMI A] or [HDMI A + B] (for STR-DN1050 only).

Notes on use

4-488-938-11(1)

Copyright 2014 Sony Corporation



MULTI CHANNEL AV RECEIVER
STR-DN1050/STR-DN850

The Audio Return Channel (ARC) function does not work.

- Make sure [Control for HDMI] is set to [On] in the HDMI Settings menu.
- Make sure [Input Mode] for the TV input is set to [Auto].
- Make sure your TV supports the ARC function.
- If your TV has multiple HDMI input jacks, make sure the receiver is connected to the one supports the ARC function.
- Make sure your TV is connected to the HDMI OUT A jack of the receiver (for STR-DN1050 only).
- Make sure the HDMI OUTPUT setting is set to [HDMI A] or [HDMI A + B] (for STR-DN1050 only).

Related Topic

- [Controlling HDMI devices \(Control for HDMI\)](#)
- [Switching between digital and analog audio \(Input Mode\)](#)

[Notes on use](#)

4-488-938-11(1)

Copyright 2014 Sony Corporation



MULTI CHANNEL AV RECEIVER
STR-DN1050/STR-DN850

An MHL-compatible source device cannot be charged.

- Check that the receiver is turned on.
- Make sure the device is connected securely.

[Notes on use](#)

4-488-938-11(1)

Copyright 2014 Sony Corporation



MULTI CHANNEL AV RECEIVER
STR-DN1050/STR-DN850

No image from an MHL-compatible source device.

- Check the settings of your device. For details, refer to the operating instructions of your device.
- Check that the device is connected via an MHL cable to the HDMI/MHL (VIDEO 2 IN) (*1), HDMI VIDEO 1 IN (MHL) (*1) or HDMI VIDEO IN (MHL) (*2) jacks.

*1 For STR-DN1050 only

*2 For STR-DN850 only

[Notes on use](#)

4-488-938-11(1)

Copyright 2014 Sony Corporation



MULTI CHANNEL AV RECEIVER
STR-DN1050/STR-DN850

The remote control does not function.

- Point the remote control at the remote control sensor on the receiver.
- Remove any obstructions between the remote control and the receiver.
- Replace both of the batteries in the remote control with new ones if they are weak.

[Notes on use](#)

4-488-938-11(1)

Copyright 2014 Sony Corporation



MULTI CHANNEL AV RECEIVER
STR-DN1050/STR-DN850

Customer support websites

Refer to the following websites for the latest information on the receiver.

For customers in the USA:

<http://esupport.sony.com/>

For customers in Canada:

<http://esupport.sony.com/CA/>

For customers in Latin America:

http://esupport.sony.com/LA

For customers in Europe:

<http://support.sony-europe.com/>

For customers in Australia:

<http://www.sony-asia.com/support>

Notes on use

4-488-938-11(1)

Copyright 2014 Sony Corporation

MULTI CHANNEL AV RECEIVER
STR-DN1050/STR-DN850

5.1-channel speaker system

To fully enjoy theater-like multi-channel surround sound, you need five speakers (two front speakers, a center speaker, and two surround speakers) and a subwoofer.

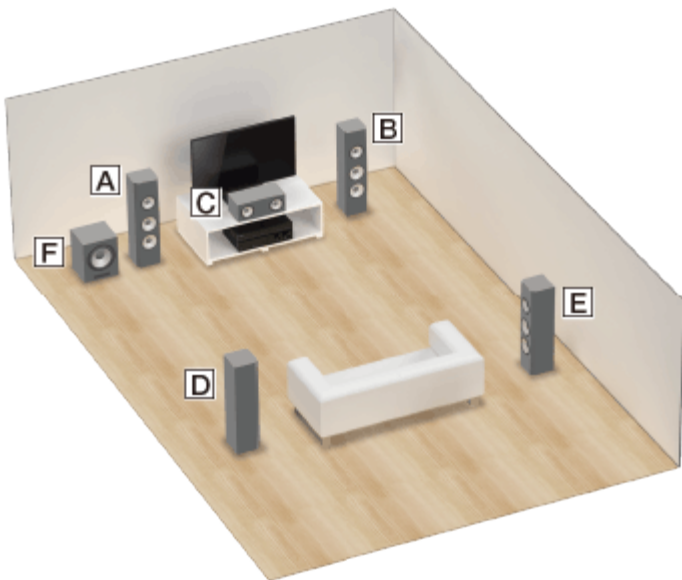

- A** Front speaker (Left)
- B** Front speaker (Right)
- C** Center speaker
- D** Surround speaker (Left)
- E** Surround speaker (Right)
- F** Subwoofer

Hint

- As the subwoofer does not emit highly directional signals, you can place it wherever you want.

[Notes on use](#)

4-488-938-11(1)

Copyright 2014 Sony Corporation

MULTI CHANNEL AV RECEIVER
STR-DN1050/STR-DN850

7.1-channel speaker system using surround back speakers

You can enjoy high-fidelity reproduction of recorded sound from DVD or Blu-ray Disc software in 6.1-channel or 7.1-channel format.

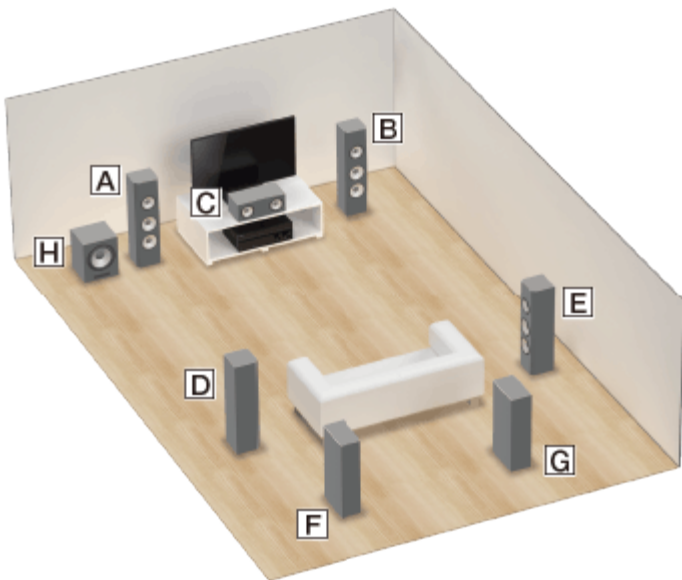

- A** Front speaker (Left)
- B** Front speaker (Right)
- C** Center speaker
- D** Surround speaker (Left)
- E** Surround speaker (Right)
- F** Surround back speaker (Left)
- G** Surround back speaker (Right)
- H** Subwoofer

6.1-channel speaker placement

Place the surround back speaker behind the listening position.

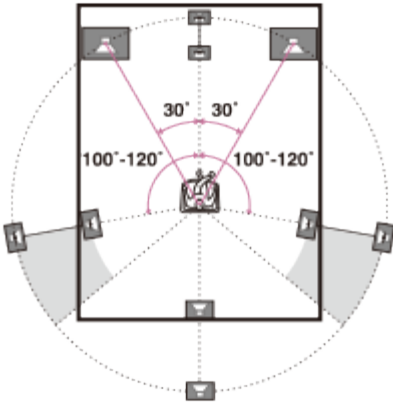

7.1-channel speaker placement

Place the surround back speakers as shown in the illustration below. The angles shown by **A** should be the same.

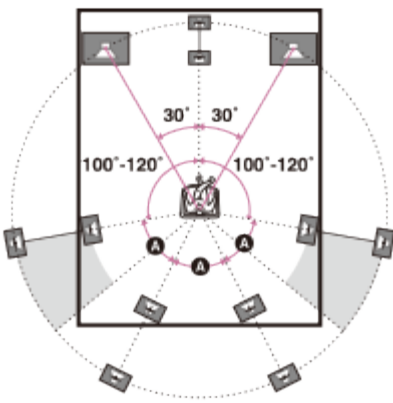

Hint

- As the subwoofer does not emit highly directional signals, you can place it wherever you want.

Notes on use

4-488-938-11(1)

Copyright 2014 Sony Corporation

MULTI CHANNEL AV RECEIVER
STR-DN1050/STR-DN850

7.1-channel speaker system using front high speakers

You can enjoy vertical sound effects by connecting additional two front high speakers.

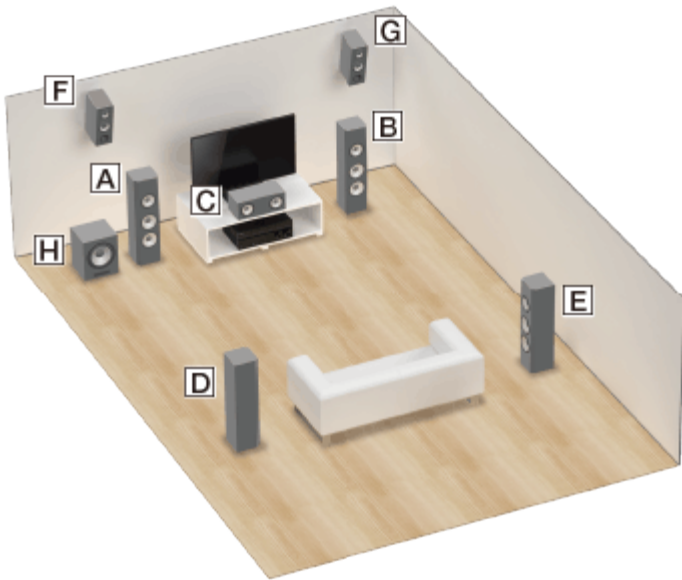

- A** Front speaker (Left)
- B** Front speaker (Right)
- C** Center speaker
- D** Surround speaker (Left)
- E** Surround speaker (Right)
- F** Front high speaker (Left)
- G** Front high speaker (Right)
- H** Subwoofer

1. Place the front high speakers at an angle between 25° and 35°.

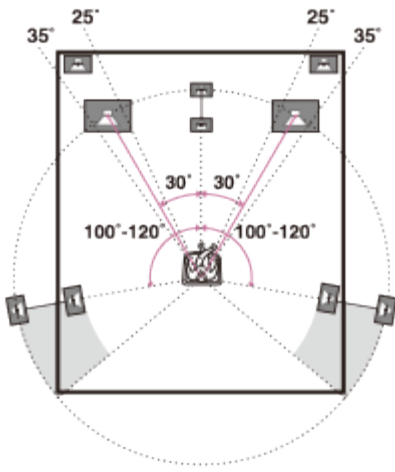

2. Place the front high speakers at height angle of $20^\circ \pm 5^\circ$.

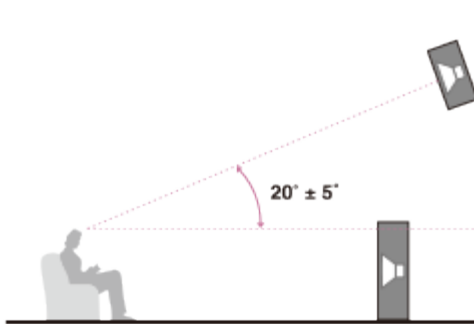

Hint

- As the subwoofer does not emit highly directional signals, you can place it wherever you want.

Notes on use

4-488-938-11(1)

Copyright 2014 Sony Corporation

MULTI CHANNEL AV RECEIVER
STR-DN1050/STR-DN850

How to connect speaker cables

Connect speaker cables as illustrated below.

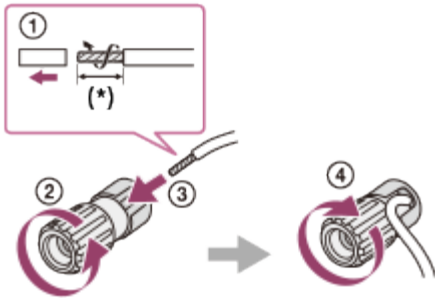

* Strip the jacket to 10 mm (13/32 in) at each end of the speaker cables.

[Notes on use](#)

4-488-938-11(1)

Copyright 2014 Sony Corporation



MULTI CHANNEL AV RECEIVER
STR-DN1050/STR-DN850

Checking the information of a connected BLUETOOTH device

You can check the BLUETOOTH device information by pressing DISPLAY repeatedly.

Each time you press DISPLAY, the display will change cyclically as follows:

BLUETOOTH device name - BLUETOOTH device address - Sound field currently applied - Volume level - Input you selected

[Notes on use](#)

4-488-938-11(1)

Copyright 2014 Sony Corporation



MULTI CHANNEL AV RECEIVER
STR-DN1050/STR-DN850

Naming preset stations (Name Input)

1. Select [Listen] - [FM TUNER] or [AM TUNER] from the home menu.
2. Select the preset number to which you want to assign a name.
3. Press OPTIONS.
The options menu appears.
4. Select [Name Input].
An on-screen keyboard appears on the TV screen.
5. Press / / / and to select characters one by one to enter the name.
6. Select [Enter].
The name you entered is registered.

Canceling naming input

Press RETURN.

Note

- Some letters that can be displayed on the TV screen cannot be displayed on the display panel.

Notes on use

4-488-938-11(1)

Copyright 2014 Sony Corporation



MULTI CHANNEL AV RECEIVER
STR-DN1050/STR-DN850

Auto Format Direct (A.F.D.)/2-channel sound mode

- Auto Format Direct (A.F.D.) mode: This mode allows you to listen to higher-fidelity sound and select the decoding mode for listening to a 2-channel stereo or monaural sound as multi-channel sound.
- 2-channel sound mode: You can switch the output sound to 2-channel sound regardless of the recording formats of the software you are using, the playback device connected, or the sound field settings of the receiver.

A.F.D. Auto (A.F.D. AUTO):

Presets the sound as it was recorded/encoded without adding any surround effects.

However, for USA and Canada models, this receiver will generate a low-frequency signal for output to the subwoofer when there is no LFE signals.

Multi Stereo (MULTI ST.):

Outputs 2-channel left/right or monaural signals from all speakers. However, sound may not be output from certain speakers depending on the speaker settings.

2ch Stereo (2CH ST.):

The receiver outputs the sound from the front left/right speakers only. There is no sound from the subwoofer.

Standard 2-channel stereo sources completely bypass the sound field processing and multi-channel surround formats are downmixed to 2-channels.

2ch Analog Direct (A. DIRECT):

You can switch the audio of the selected input to 2-channel analog input. This function enables you to enjoy high-quality analog sources.

Only the volume and front speaker level can be adjusted when using this function.

Note

- You cannot select [2ch Analog Direct] while using the BD/DVD, GAME, VIDEO 2, BLUETOOTH, USB, Home Network, Music Services, or AirPlay function.
- [Multi Stereo] does not work when multi-channel audio signals are being received.

Notes on use

4-488-938-11(1)

Copyright 2014 Sony Corporation



MULTI CHANNEL AV RECEIVER
STR-DN1050/STR-DN850

Movie mode

You can take advantage of surround sound simply by selecting one of the receiver's pre-programmed sound fields. They bring the exciting and powerful sound of movie theaters into your home.

HD-D.C.S.:

HD Digital Cinema Sound (HD-D.C.S.) is Sony's new innovative home theater technology using the latest acoustic and digital signal processing technologies. It is based on the precise response measurement data of a mastering studio. With this mode, you can enjoy Blu-ray and DVD movies at home with not only a high-quality of sound but also the best sound ambience, just as the movie's sound engineer intended in the mastering process.

- **Dynamic:** This setting is suitable for an environment which is reverberant but lacks a spacious feel (where sound absorption is not sufficient). It emphasizes the reflection of sound and reproduces the sound of a large, classic movie theater. This emphasizes the spacious feel of a dubbing theater and creates a unique acoustic field.
- **Theater:** This setting is suitable for a general living room. It reproduces the reverberation of sound just like in a movie theater (dubbing theater). It is most appropriate for watching content recorded on a Blu-ray Disc when you want the atmosphere of a movie theater.
- **Studio:** This setting is suitable for a living room with the appropriate sound devices. It reproduces the reverberation of sound provided when a theatrical sound source is remixed for a Blu-ray Disc to a volume level suitable for home use. The level of reflection and reverberation of sound is kept to a minimum, while dialogues and surround effects are reproduced vividly.

PLII Movie:

Performs Dolby Pro Logic II Movie mode decoding. This setting is ideal for movies encoded in Dolby Surround. In addition, this mode can reproduce sound in 5.1-channel format when watching videos of overdubbed or old movies.

PLIIx Movie:

Performs Dolby Pro Logic IIx Movie mode decoding. This setting expands Dolby Pro Logic II Movie or Dolby Digital 5.1 to 7.1 discrete movie channels.

Neo:6 Cinema (Neo:6 CIN):

Performs DTS Neo:6 Cinema mode decoding. Sources recorded in 2-channel format are enhanced up to 7 channels.

[Notes on use](#)

4-488-938-11(1)

Copyright 2014 Sony Corporation



MULTI CHANNEL AV RECEIVER
STR-DN1050/STR-DN850

Music mode

You can take advantage of surround sound simply by selecting one of the receiver's pre-programmed sound fields. These bring the exciting and powerful sound of concert halls into your home.

Berlin Philharmonic Hall (BERLIN):

Reproduces the sound characteristics of the Berlin Philharmonic Hall.

Concertgebouw Amsterdam (CONCERTGEB):

Reproduces the sound characteristics produced by the reflectivity of a concert hall in Amsterdam, Netherlands that features a large sound stage.

Musikverein Vienna (MUSIKVEREI):

Reproduces the sound characteristics of a concert hall in Vienna, Austria that features a resonant and unique reverberative sound.

Jazz Club (JAZZ):

Reproduces the acoustics of a jazz club.

Live Concert (CONCERT):

Reproduces the acoustics of a 300-seat live house.

Stadium (STADIUM):

Reproduces the feel of a large open-air stadium.

Sports (SPORTS):

Reproduces the feel of sports broadcasting.

Portable Audio (PORTABLE):

Reproduces clear enhanced sound from your portable audio device. This mode is ideal for MP3s and other compressed music.

PLII Music:

Performs Dolby Pro Logic II Music mode decoding. This setting is ideal for normal stereo sources such as CDs.

PLIIX Music:

Performs Dolby Pro Logic IIX Music mode decoding. This setting is ideal for normal stereo sources such as CDs.

Neo:6 Music (Neo:6 MUS):

Performs DTS Neo:6 Music mode decoding. Sources recorded in 2-channel format are enhanced up to 7 channels. This setting is ideal for normal stereo sources such as CDs.



MULTI CHANNEL AV RECEIVER
STR-DN1050/STR-DN850

When headphones are connected

You can only select this sound field if headphones are connected to the receiver.

Headphone (2ch) (HP 2CH) :

This mode is selected automatically if you use headphones (except when [2ch Analog Direct] is selected). Standard 2-channel stereo sources completely bypass the sound field processing and multi-channel surround formats are downmixed to 2 channels except LFE signals.

Headphone (Direct) (HP DIRECT) :

This mode is selected automatically if you use headphones when [2ch Analog Direct] is selected.
This mode outputs analog signals without processing by the equalizer, sound field, etc.

[Notes on use](#)

4-488-938-11(1)

Copyright 2014 Sony Corporation



MULTI CHANNEL AV RECEIVER
STR-DN1050/STR-DN850

Compatible formats with DLNA

The music file formats that can be played back by this receiver are as follows:

MP3 (MPEG 1 Audio Layer-3):

32 kbps – 320 kbps, VBR

AAC (*):

16 kbps – 320 kbps, CBR, VBR

WMA9 Standard (*):

40 kbps – 320 kbps, CBR, VBR

WAV:

8 kHz – 192 kHz, 16/24 bit PCM

FLAC:

44.1 kHz – 192 kHz, 16/24 bit FLAC

AIFF:

8 kHz – 192 kHz, 16/24 bit PCM

ALAC:

32 kHz - 96 kHz, 16/24 bit ALAC

DSD (for STR-DN1050 only):

2.8 MHz, 1 bit DSD

* The receiver does not play files encoded with DRM.

Note

- Compatibility with all encoding/writing software, recording devices and recording media cannot be guaranteed.

[Notes on use](#)

4-488-938-11(1)

Copyright 2014 Sony Corporation



MULTI CHANNEL AV RECEIVER
STR-DN1050/STR-DN850

Deleting devices from the device list in DLNA Control Permission

1. Select [Settings] - [Network Settings] from the home menu.
2. Select [DLNA Control Permission].
3. Select the device you want.
4. Select [Remove].
5. Select [OK].

The selected device is deleted from the device list.

[Notes on use](#)

4-488-938-11(1)

Copyright 2014 Sony Corporation



MULTI CHANNEL AV RECEIVER
STR-DN1050/STR-DN850

Deleting registered TV SideView devices from the device list

1. Select [Settings] - [Network Settings] from the home menu.
2. Select [TV SideView Setup].
3. Select the device you want to delete.
4. Select [Delete].
5. Select [OK].

The selected device is deleted from the device list.

[Notes on use](#)

4-488-938-11(1)

Copyright 2014 Sony Corporation



MULTI CHANNEL AV RECEIVER
STR-DN1050/STR-DN850

Enjoying an input source from a connected device immediately (One-Touch Play)

When you play content on a device connected to the receiver via an HDMI connection, the receiver is also automatically turned on and switched to the appropriate HDMI input.

Note

- Depending on the TV, the start of the content may not appear.

Related Topic

- [Passing HDMI signals through \(Pass Through\)](#)

[Notes on use](#)

4-488-938-11(1)

Copyright 2014 Sony Corporation



MULTI CHANNEL AV RECEIVER
STR-DN1050/STR-DN850

Enjoying TV sound from the speakers connected to the receiver (System Audio Control)

You can use the System Audio Control function as follows:

- The sound of the TV is output from the speakers connected to the receiver if you turn the receiver on while sound is being output from the TV speaker. If you turn off the receiver, the sound is output from the TV speaker.
- When you adjust the TV volume, the System Audio Control function adjusts the volume of the receiver simultaneously.

Note

- When [Control for HDMI] is set to [On], the [Audio Out] settings in the HDMI Settings menu will be set automatically based on the System Audio Control settings.

Hint

- You can also operate this function using the TV menu. For details, refer to the operating instructions of the TV.

Notes on use

4-488-938-11(1)



Copyright 2014 Sony Corporation



MULTI CHANNEL AV RECEIVER
STR-DN1050/STR-DN850

Turning off the receiver and connected devices simultaneously with the TV (System Power Off)

If the TV, receiver and any connected devices are connected to each other via HDMI connections, you can turn them off simultaneously by pressing either of the following buttons:

-  on the remote control of the TV
-  on the remote control of the receiver

Note

- Turn on the power supply interlock function of the TV before using the System Power Off function. For details, refer to the operating instructions of the TV.
- Some connected devices may not be turned off depending on their specifications. For details, refer to the operating instructions of the connected device.

[Notes on use](#)

4-488-938-11(1)

Copyright 2014 Sony Corporation



MULTI CHANNEL AV RECEIVER
STR-DN1050/STR-DN850

Selecting the optimum picture quality and sound field automatically (Scene Select)

The optimum picture quality and sound field are selected automatically according to the scene selected on your TV. For details on this operation, refer to the operating instructions of the TV.

Switching the sound field for the scene selected on your TV (Scene: Sound field)

- Cinema: HD-D.C.S.
- Sports: Sports
- Music: Live Concert
- Animation: A.F.D. Auto
- Photo: A.F.D. Auto
- Game: A.F.D. Auto
- Graphics: A.F.D. Auto

Note

- The sound field may not change depending on some TVs.

[Notes on use](#)

4-488-938-11(1)

Copyright 2014 Sony Corporation



MULTI CHANNEL AV RECEIVER
STR-DN1050/STR-DN850

Home Theatre Control

If a Home Theatre Control-compatible TV is connected to the receiver, an icon for Internet based applications appears on the connected TV.

You can switch an input of the receiver or switch sound fields by using the remote control of your TV. You can also adjust the level of the center speaker or the subwoofer, or adjust the settings of [Sound Optimizer], [Dual Mono], or [A/V Sync].

Note

- Your TV must be able to access a broadband service to use the Home Theatre Control function.

[Notes on use](#)

4-488-938-11(1)

Copyright 2014 Sony Corporation



MULTI CHANNEL AV RECEIVER
STR-DN1050/STR-DN850

Operating the receiver menu using the TV remote control (Remote Easy Control)

You can use the remote control of the TV to operate the menu of the receiver. For details, refer to the operating instructions of the TV.

Note

- The receiver is recognized as [Tuner] by the TV.
- Your TV must support the link menu.
- Some of the operations may not be available depending on the type of TV.

[Notes on use](#)

4-488-938-11(1)

Copyright 2014 Sony Corporation

MULTI CHANNEL AV RECEIVER
STR-DN1050/STR-DN850

Controlling MHL devices

By connecting an MHL device with an MHL cable (not supplied), you can use One-Touch Play and Remote Easy Control.

Note

- This function allows communication with Sony “BRAVIA” Sync-compatible TVs using an HDMI cable (not supplied).
- This function may not work depending on the connected MHL device.
- This function can only work when:
 - The receiver is turned on.
 - [Control for HDMI] is set to [On].
 - The MHL device is connected via an MHL cable (not supplied) to the HDMI/MHL (VIDEO 2 IN) (for STR-DN1050 only), HDMI VIDEO 1 IN (MHL) (for STR-DN1050 only) or HDMI VIDEO IN (MHL) (for STR-DN850 only) jack.

One-Touch Play

The receiver switches to the appropriate input when you connect, play content, etc. from your MHL device.

Remote Easy Control

You can use the / / / , , RETURN, OPTIONS, HOME (*), , , and / buttons on the remote control to control your MHL device.

* Hold down HOME to display the home menu of the MHL device.

Related Topic

- [Using MHL \(Mobile High-Definition Link\) connections](#)
- [Controlling HDMI devices \(Control for HDMI\)](#)

Notes on use

4-488-938-11(1)

Copyright 2014 Sony Corporation

MULTI CHANNEL AV RECEIVER
STR-DN1050/STR-DN850

Before you perform Auto Calibration

Before you perform Auto Calibration, check the following items:

- Set up and connect the speakers.
- Do not connect any microphones other than the supplied optimizer microphone to the AUTO CAL MIC jack.
- If using a bi-amplifier connection or speakers with a front B connection, set the assignment for the SPEAKERS SURROUND BACK/BI-AMP/FRONT HIGH/FRONT B terminals properly. For details, see “[Selecting the speaker pattern and setting the assignment for the speaker terminals \(Speaker Connection/SB Speaker Assign\)](#).”
- Set the speaker output to a setting other than [SPK OFF]. For details, see “[Selecting the front speakers](#).”
- Disconnect the headphones.
- Remove any obstructions between the optimizer microphone and the speakers.
- For accurate measurement, make sure the environment is quiet and free from noise.

Note

- The speakers emit very loud sound during the calibration and the volume cannot be adjusted. Be considerate of your neighbors and any children who are present.
- If the muting function has been activated before you perform Auto Calibration, the muting function will shut off automatically.
- It may not be possible to take the correct measurements or to perform Auto Calibration at all if special speakers such as dipole speakers are used.

Related Topic

- [Confirming active subwoofer setup](#)
- [Selecting the front speakers](#)
- [Connecting the optimizer microphone](#)

[Notes on use](#)

4-488-938-11(1)

Copyright 2014 Sony Corporation

MULTI CHANNEL AV RECEIVER
STR-DN1050/STR-DN850

Connecting the optimizer microphone

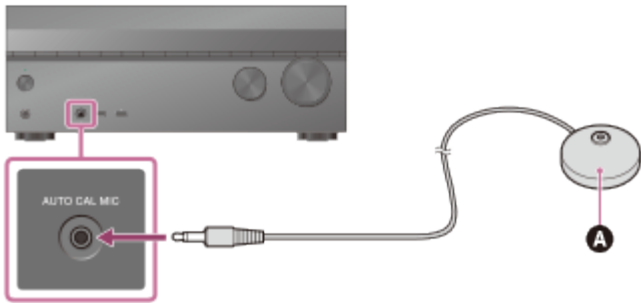

A Optimizer microphone (supplied)

1. Connect the supplied optimizer microphone to the AUTO CAL MIC jack.
2. Set up the optimizer microphone.
Place the optimizer microphone where you will sit and set it at the same height as your ears.

[Notes on use](#)

4-488-938-11(1)

Copyright 2014 Sony Corporation

MULTI CHANNEL AV RECEIVER
STR-DN1050/STR-DN850

Selecting the front speakers

You can select the front speakers you want to operate.
Be sure to use the buttons on the receiver to perform this operation.

1. Press SPEAKERS on the receiver repeatedly to select the front speaker system you want to operate.



The indicators on the display panel shows which set of terminals are selected.

- SP A :
Speakers connected to the SPEAKERS FRONT A terminals.
- SP B (*):
Speakers connected to the SPEAKERS SURROUND BACK/BI-AMP/FRONT HIGH/FRONT B terminals.
- SP A+B (*):
Speakers connected to both the SPEAKERS FRONT A and SPEAKERS SURROUND BACK/BI-AMP/FRONT HIGH/FRONT B terminals (parallel connection).
- (None):
[SPK OFF] appears on the display panel. No audio signals are output from any speaker terminals.

* To select [SP B] or [SP A+B], set the assignment for the SPEAKERS SURROUND BACK/BI-AMP/FRONT HIGH/FRONT B terminals to [Front B] by using [SB Speaker Assign] in the Speaker Settings menu.

Note

- This setting is not available when headphones are connected.



MULTI CHANNEL AV RECEIVER
STR-DN1050/STR-DN850

About Auto Calibration

Auto Calibration allows you to perform automatic calibration as follows.

- Check the connection between each speaker and the receiver.
- Adjust the speaker level.
- Measure the distance of each speaker from your seating position. (*1)
- Measure the speaker size. (*1)
- Measure the frequency characteristics (EQ). (*1)
- Measure the frequency characteristics (Phase). (*1, *2)

*1 The measurement result is not utilized when [2ch Analog Direct] is selected.

*2 The measurement result may be not utilized, depending on the audio formats.

Note

- The D.C.A.C. is designed to achieve proper sound balance for your room. However, you can adjust the speaker levels manually according to your preference using [Test Tone].

Related Topic

- [Outputting a test tone from each speaker \(Test Tone\)](#)

Notes on use

4-488-938-11(1)

Copyright 2014 Sony Corporation

MULTI CHANNEL AV RECEIVER
STR-DN1050/STR-DN850

Confirming active subwoofer setup

- When a subwoofer is connected, turn on the subwoofer and turn up the volume prior to activating the subwoofer. Turn the LEVEL to just before the mid-point.
- If you connect a subwoofer with a crossover frequency function, set the value to maximum.
- If you connect a subwoofer with an auto standby function, set it to off (deactivated).

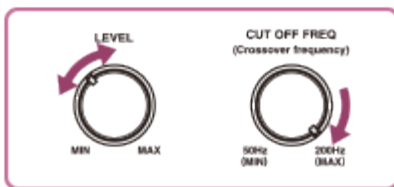

Note

- Depending on the characteristics of the subwoofer you are using, the setup distance value may be different from the actual position.

Notes on use

4-488-938-11(1)

Copyright 2014 Sony Corporation

MULTI CHANNEL AV RECEIVER
STR-DN1050/STR-DN850

Checking Auto Calibration results

To check error codes or warning messages received in [Auto Calibration], proceed with the following steps:

If an error code appears

Check the error and perform Auto Calibration again.

1. Select [Retry].
2. Follow the instructions on the TV screen and then press **+** to select [Start].
The measurement starts in five seconds.
The measurement process will take approximately 30 seconds with a test tone.
When the measurement ends, a beep sounds and the screen switches.
3. Select the item you want.
 - Save: Saves the measurement results and exits the setting process.
 - Retry: Performs the Auto Calibration again.
 - Discard: Exits the setting process without saving the measurement results.
4. Save the measurement results.
Select [Save] in step 3.

If a warning message appears

Check the warning message and select [OK]. For details on the warning messages, see “[List of messages after Auto Calibration measurements.](#)”

Hint

- The measurement results may vary depending on the position of the subwoofer. However, continuing to use the receiver with that value does not cause problems.

Related Topic

[List of messages after Auto Calibration measurements](#)

Notes on use

4-488-938-11(1)

Copyright 2014 Sony Corporation



MULTI CHANNEL AV RECEIVER
STR-DN1050/STR-DN850

Menu list (on the display panel)

The following options are available in each menu.

Auto Calibration settings [<AUTO CAL>]

- Auto Calibration start [A.CAL START]
- Auto Calibration type [CAL TYPE] (*1)
FULL FLAT, ENGINEER, FRONT REF, OFF
- Automatic Phase Matching [A.P.M.] (*1)
A.P.M. AUTO, A.P.M. OFF

Level settings [<LEVEL>]

- Test Tone [TEST TONE] (*2) OFF, AUTO XXX (*3), FIX XXX (*3)
- Front left speaker level [FL LEVEL] (*2)
FL -10.0 dB to FL +10.0 dB (0.5 dB interval)
- Front right speaker level [FR LEVEL] (*2)
FR -10.0 dB to FR +10.0 dB (0.5 dB interval)
- Center speaker level [CNT LEVEL] (*2)
CNT -10.0 dB to CNT +10.0 dB (0.5 dB interval)
- Surround left speaker level [SL LEVEL] (*2)
SL -10.0 dB to SL +10.0 dB (0.5 dB interval)
- Surround right speaker level [SR LEVEL] (*2)
SR -10.0 dB to SR +10.0 dB (0.5 dB interval)
- Surround back speaker level [SB LEVEL] (*2)
SB -10.0 dB to SB +10.0 dB (0.5 dB interval)
- Surround back left speaker level [SBL LEVEL] (*2)
SBL -10.0 dB to SBL +10.0 dB (0.5 dB interval)
- Surround back right speaker level [SBR LEVEL] (*2)
SBR -10.0 dB to SBR +10.0 dB (0.5 dB interval)
- Front left high speaker level [LH LEVEL] (*2)
LH -10.0 dB to LH +10.0 dB (0.5 dB interval)
- Front right high speaker level [RH LEVEL] (*2)
RH -10.0 dB to RH +10.0 dB (0.5 dB interval)
- Subwoofer Level [SW LEVEL] (*2)
SW -10.0 dB to SW +10.0 dB (0.5 dB interval)

Speaker settings [<SPEAKER>]

- Speaker pattern [SP PATTERN]
5/2.1 to 2/0 (20 patterns)

- Center Speaker Lift Up [CNT LIFT] (*2)
1 to 10, OFF
- Front speakers size [FRT SIZE] (*2)
LARGE, SMALL
- Center speaker size [CNT SIZE] (*2)
LARGE, SMALL
- Surround speakers size [SUR SIZE] (*2)
LARGE, SMALL
- Front high speakers size [FH SIZE] (*2)
LARGE, SMALL
- Surround back speaker assign [SB ASSIGN] (*4)
SPK B, ZONE2 (for STR-DN1050 only), BI-AMP, OFF
- Front left speaker distance [FL DIST.] (*2)
FL 1.00 m to FL 10.00 m (FL 3'3" to FL 32'9") (0.01 m (1 inch) interval)
- Front right speaker distance [FR DIST.] (*2)
FR 1.00 m to FR 10.00 m (FR 3'3" to FR 32'9") (0.01 m (1 inch) interval)
- Center speaker distance [CNT DIST.] (*2)
CNT 1.00 m to CNT 10.00 m (CNT 3'3" to CNT 32'9") (0.01 m (1 inch) interval)
- Surround left speaker distance [SL DIST.] (*2)
SL 1.00 m to SL 10.00 m (SL 3'3" to SL 32'9") (0.01 m (1 inch) interval)
- Surround right speaker distance [SR DIST.] (*2)
SR 1.00 m to SR 10.00 m (SR 3'3" to SR 32'9") (0.01 m (1 inch) interval)
- Surround back speaker distance [SB DIST.] (*2)
SB 1.00 m to SB 10.00 m (SB 3'3" to SB 32'9") (0.01 m (1 inch) interval)
- Surround back left speaker distance [SBL DIST.] (*2)
SBL 1.00 m to SBL 10.00 m (SBL 3'3" to SBL 32'9") (0.01 m (1 inch) interval)
- Surround back right speaker distance [SBR DIST.] (*2)
SBR 1.00 m to SBR 10.00 m (SBR 3'3" to SBR 32'9") (0.01 m (1 inch) interval)
- Front left high speaker distance [LH DIST.] (*2)
LH 1.00 m to LH 10.00 m (LH 3'3" to LH 32'9") (0.01 m (1 inch) interval)
- Front right high speaker distance [RH DIST.] (*2)
RH 1.00 m to RH 10.00 m (RH 3'3" to RH 32'9") (0.01 m (1 inch) interval)
- Subwoofer distance [SW DIST.] (*2)
SW 1.00 m to SW 10.00 m (SW 3'3" to SW 32'9") (0.01 m (1 inch) interval)
- Distance Unit [DIST. UNIT]
FEET, METER
- Front speakers crossover frequency [FRT CROSS] (*5)
CROSS 40 Hz to CROSS 200 Hz (10 Hz interval)
- Center speaker crossover frequency [CNT CROSS] (*5)
CROSS 40 Hz to CROSS 200 Hz (10 Hz interval)
- Surround speakers crossover frequency [SUR CROSS] (*5)
CROSS 40 Hz to CROSS 200 Hz (10 Hz interval)
- Front high speakers crossover frequency [FH CROSS] (*5)
CROSS 40 Hz to CROSS 200 Hz (10 Hz interval)

Input settings [<INPUT>]

- Input Mode [INPUT MODE]
AUTO, OPT, COAX, ANALOG
- Naming inputs [NAME IN]
For details, see [“Changing the name for each input \(Name\).”](#) in Input Settings menu.
- Digital audio input assignment [A. ASSIGN]
OPT 1, OPT 2, COAX, NONE
- Component video input assignment [V. ASSIGN] (for STR-DN1050 only)
COMP 1, COMP 2, NONE

Surround settings [<SURROUND>]

- HD-D.C.S. effect type [HD-D.C.S. TYP] (*6)
DYNAMIC, THEATER, STUDIO

EQ settings [<EQ>]

- Front speakers bass level [FRT BASS]
FRT B. -10 dB to FRT B. +10 dB (1 dB interval)
- Front speakers treble level [FRT TREBLE]
FRT T. -10 dB to FRT T. +10 dB (1 dB interval)
- Center speaker bass level [CNT BASS]
CNT B. -10 dB to CNT B. +10 dB (1 dB interval)
- Center speaker treble level [CNT TREBLE]
CNT T. -10 dB to CNT T. +10 dB (1 dB interval)
- Surround speakers bass level [SUR BASS]
SUR B. -10 dB to SUR B. +10 dB (1 dB interval)
- Surround speakers treble level [SUR TREBLE]
SUR T. -10 dB to SUR T. +10 dB (1 dB interval)
- Front high speakers bass level [FH BASS]
FH B. -10 dB to FH B. +10 dB (1 dB interval)
- Front high speakers treble level [FH TREBLE]
FH T. -10 dB to FH T. +10 dB (1 dB interval)

Zone settings [<ZONE>] (for STR-DN1050 only)

- Zone 2 lineout [Z2 LINEOUT]
FIXED, VARIABLE

Tuner settings [<TUNER>]

- FM station receiving mode [FM MODE]
STEREO, MONO
- Naming preset stations [NAME IN]
For details, see [“Naming preset stations \(Name Input\).”](#)

Audio settings [<AUDIO>]

- Digital Legato Linear [D.L.L.]
D.L.L. AUTO2, D.L.L. AUTO1, D.L.L. OFF
- Sound Optimizer [OPTIMIZER]
OFF, LOW, NORMAL

- Synchronizes audio with video output [A/V SYNC]
HDMI AUTO, 0 ms to 300 ms (10 ms interval)
- Advanced Auto Volume [AUTO VOL]
A. VOL ON, A. VOL OFF
- Subwoofer Low Pass Filter [SW L.P.F.]
L.P.F. ON, L.P.F. OFF
- Digital broadcast language selection [DUAL MONO]
MAIN/SUB, MAIN, SUB
- Dynamic Range Compressor [D. RANGE]
COMP. ON, COMP. AUTO, COMP. OFF

HDMI settings [<HDMI>]

- 4K Scaling [4K SCALING] (for STR-DN1050 only)
AUTO, OFF
- Control for HDMI [CTRL: HDMI]
CTRL ON, CTRL OFF
- Pass Through [PASS THRU]
ON (*7), AUTO, OFF
- Zone2 Out [ZONE2 OUT]
ON, OFF
- Priority [PRIORITY]
MAIN&ZONE2, MAIN ONLY
- HDMI Audio Out [AUDIO OUT]
AMP, TV+AMP
- HDMI Subwoofer Level [SW LEVEL]
SW AUTO, SW +10 dB, SW 0 dB
- Fast View [FAST VIEW]
AUTO, OFF
- MHL Auto Input [MHL.AUTO IN]
ON, OFF

BLUETOOTH settings [<BT>]

- BLUETOOTH Standby mode [BT STANDBY] (*8)
STBY ON, STBY OFF
- BLUETOOTH AAC [BT AAC]
AAC ON, AAC OFF
- BLUETOOTH aptX [BT aptX]
aptX ON, aptX OFF
- BLUETOOTH Power [BT POWER]
BT ON, BT OFF

System settings [<SYSTEM>]

- Network Standby [NET STBY] (for USA and Canadian models only)
STBY ON, STBY OFF
- Auto standby mode [AUTO STBY]
STBY ON, STBY OFF

- Version display [VER. x.xxx] (*9)
- Sleep timer [SLEEP]
OFF - 0:30:00 - 1:00:00 - 1:30:00 - 2:00:00

*1 You can select this setting only when you have performed Auto Calibration and saved the settings.

*2 Some parameters or settings may not be available depending on the speaker pattern setting.

*3 XXX represents a speaker channel (FL, FR, CNT, SL, SR, SB, SBL, SBR, LH, RH, SW).

*4 You can only select this parameter if [SP PATTERN] is not set to a pattern with surround back and front high speakers.

*5 You can only select this parameter if the speaker is set to [SMALL].

*6 You can only select this parameter if you select [HD-D.C.S.] as the sound field.

*7 For USA, Canadian, Mexican, and Australian models only

*8 You can only select this parameter when a BLUETOOTH device is paired.

*9 x.xxx represents the version number.

Notes on use

4-488-938-11(1)

Copyright 2014 Sony Corporation